

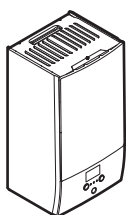

Installation manual

Daikin Altherma 3 H MT W



<https://daikintechnicaldatahub.eu>



ETBH12EF6V
ETBH12EF9W
ETBX12EF6V
ETBX12EF9W

Installation manual
Daikin Altherma 3 H MT W

English

- CE - DECLARACIONE-DE-CONFORMIDAD
- CE - KONFORMITÄTSEKLERÄRNING
- CE - DICHIARAZIONE-DI-CONFORMITÀ
- CE - ΔΗΛΩΣΗ ΤΗΜΟΡΦΩΣΗΣ
- CE - DECLARACIÓN-DE-CONFORMIDAD
- CE - ЗАЯВЛЕНИЕ О СООТВЕТСТВИИ
- CE - OVERENSSTEMMINGSERKLÆRING
- CE - FÖRSÄKRAN OM ÖVERENSSTÄMMELSE

- CE - ERKLÆRING OM SAMSVAR
- CE - ЛУЧШОСЪВЪДИТЕЛНОСТ
- CE - MEĞFELERİ ÖSEĞİMLİK KOZAK
- CE - DEKLARACIJA ZGODNOSTI
- CE - DECLARAȚIE DE CONFORMITATE
- CE - PROHLÁŠENÍ SHODY
- CE - DECLARAZIONE DI CONFORMITÀ
- CE - ЗАЯВЛЕНИЕ О СООТВЕТСТВИИ
- CE - OVERENSSTEMMINGSERKLÆRING
- CE - FÖRSÄKRAN OM ÖVERENSSTÄMMELSE

- CE - ZJAVNA O-SKLAJENOSTI
- CE - VASTAVISEKLERÄRNING
- CE - DEKLARACIJA ZGODNOSTI
- CE - DECLARAȚIE DE CONFORMITATE
- CE - ATTIKTES-DEKLARACIJA
- CE - ATBIŠTĪBAS DEKLARĀCIJA
- CE - VYHLÁŠENÍ SHODY
- CE - UYGUNLUK BEYANI

- CE - ZJAVNA O-SKLAJENOSTI
- CE - VASTAVISEKLERÄRNING
- CE - DEKLARACIJA ZGODNOSTI
- CE - DECLARAȚIE DE CONFORMITATE
- CE - ATTIKTES-DEKLARACIJA
- CE - ATBIŠTĪBAS DEKLARĀCIJA
- CE - VYHLÁŠENÍ SHODY
- CE - UYGUNLUK BEYANI

Daikin Europe N.V.

- 01 (en) declares under its sole responsibility that the equipment to which this declaration relates;
- 02 (fr) déclare sous sa seule responsabilité que l'équipement auquel cette déclaration s'applique;
- 03 (de) erklärt die alleinige Verantwortung für die diese Erklärung betrimmt ist;
- 04 (es) declara sous sa seule responsabilité que l'équipement visé par la présente déclaration;
- 05 (it) dichiara sotto la propria responsabilità che gli apparecchi a cui è riferita questa dichiarazione;
- 06 (nl) verklaart hierbij de eigen oorspronkelijke verantwoordelijkheid dat de apparatuur waaraan deze verklaring betrekking heeft;
- 07 (pt) declara sob a sua exclusiva responsabilidade que os equipamentos a que esta declaração se refere;
- 08 (ru) объявляет под своей ответственностью, что оборудование, к которому относится настоящее заявление;
- 09 (sk) zodáva za svoje zodpovednosti, že zariadenia, ktorých táto deklarácia týka;
- 10 (sl) izjavlja, da je samostojno odgovoren za vse opremlitve, na katere se ta izjava nanaša;
- 11 (sv) uttalar under eget ansvar för utrustningen som berörs av denna deklARATION innehållt allt;
- 12 (tr) açıklar ki bu beyan sadece kendisinin sorumluluğunda olduğunu ve bu beyanla ilgili olarak herhangi bir sorumluluğundan sorumlu olmadığını;
- 13 (uk) заявляє про свою відповідальність за обладнання, до якого стосується це оголошення;
- 14 (hr) izjavlja pod svojim odgovornosti da oprema na koju se ovo izjava odnosi;
- 15 (pl) oświadcza pod swoją odpowiedzialnością, że urządzenia, na które to dotyczy toż wyłączenie;
- 16 (hr) izjavlja pod svojim odgovornosti da oprema na koju se ovo izjava odnosi;
- 17 (ru) объявляет под своей ответственностью, что оборудование, к которому относится настоящее заявление;
- 18 (en) declares under its sole responsibility that the equipment to which this declaration relates;
- 19 (fr) déclare sous sa seule responsabilité que l'équipement auquel cette déclaration s'applique;
- 20 (de) erklärt die alleinige Verantwortung für die diese Erklärung betrimmt ist;
- 21 (es) declara sous sa seule responsabilité que l'équipement visé par la présente déclaration;
- 22 (it) dichiara sotto la propria responsabilità che gli apparecchi a cui è riferita questa dichiarazione;
- 23 (nl) verklaart hierbij de eigen oorspronkelijke verantwoordelijkheid dat de apparatuur waaraan deze verklaring betrekking heeft;
- 24 (pt) declara sob a sua exclusiva responsabilidade que os equipamentos a que esta declaração se refere;
- 25 (ru) объявляет под своей ответственностью, что оборудование, к которому относится настоящее заявление;
- 26 (sk) zodáva za svoje zodpovednosti, že zariadenia, ktorých táto deklarácia týka;
- 27 (sl) izjavlja, da je samostojno odgovoren za vse opremlitve, na katere se ta izjava nanaša;
- 28 (sv) uttalar under eget ansvar för utrustningen som berörs av denna deklARATION innehållt allt;
- 29 (tr) açıklar ki bu beyan sadece kendisinin sorumluluğunda olduğunu ve bu beyanla ilgili olarak herhangi bir sorumluluğundan sorumlu olmadığını;
- 30 (uk) заявляє про свою відповідальність за обладнання, до якого стосується це оголошення;
- 31 (hr) izjavlja pod svojim odgovornosti da oprema na koju se ovo izjava odnosi;
- 32 (pl) oświadcza pod swoją odpowiedzialnością, że urządzenia, na które to dotyczy toż wyłączenie;
- 33 (hr) izjavlja pod svojim odgovornosti da oprema na koju se ovo izjava odnosi;

- 17 (ru) декларация на вѣстна љивљазна одговорностнаш, же узрэдзѣна, кѣрѣх ља декларацја доцѣлѣ; декларация на вѣстна одговорностнаш, же узрэдзѣна, кѣрѣх ља декларацја доцѣлѣ; декларация на вѣстна одговорностнаш, же узрэдзѣна, кѣрѣх ља декларацја доцѣлѣ;
- 18 (en) declares under its sole responsibility that the equipment to which this declaration relates;
- 19 (fr) déclare sous sa seule responsabilité que l'équipement auquel cette déclaration s'applique;
- 20 (de) erklärt die alleinige Verantwortung für die diese Erklärung betrimmt ist;
- 21 (es) declara sous sa seule responsabilité que l'équipement visé par la présente déclaration;
- 22 (it) dichiara sotto la propria responsabilità che gli apparecchi a cui è riferita questa dichiarazione;
- 23 (nl) verklaart hierbij de eigen oorspronkelijke verantwoordelijkheid dat de apparatuur waaraan deze verklaring betrekking heeft;
- 24 (pt) declara sob a sua exclusiva responsabilidade que os equipamentos a que esta declaração se refere;
- 25 (ru) объявляет под своей ответственностью, что оборудование, к которому относится настоящее заявление;
- 26 (sk) zodáva za svoje zodpovednosti, že zariadenia, ktorých táto deklarácia týka;
- 27 (sl) izjavlja, da je samostojno odgovoren za vse opremlitve, na katere se ta izjava nanaša;
- 28 (sv) uttalar under eget ansvar för utrustningen som berörs av denna deklARATION innehållt allt;
- 29 (tr) açıklar ki bu beyan sadece kendisinin sorumluluğunda olduğunu ve bu beyanla ilgili olarak herhangi bir sorumluluğundan sorumlu olmadığını;
- 30 (uk) заявляє про свою відповідальність за обладнання, до якого стосується це оголошення;
- 31 (hr) izjavlja pod svojim odgovornosti da oprema na koju se ovo izjava odnosi;
- 32 (pl) oświadcza pod swoją odpowiedzialnością, że urządzenia, na które to dotyczy toż wyłączenie;
- 33 (hr) izjavlja pod svojim odgovornosti da oprema na koju se ovo izjava odnosi;

ETBH12EF6V, ETBH12EF9W, ETBX12EF6V, ETBX12EF9W,

- 01 are in conformity with the following standard(s) or other normative document(s), provided that these are used in accordance with our instructions;
- 02 werden (folgende Normen) oder einem anderen Normdokument oder Dokumenten entsprechend, unter der Voraussetzung, daß sie gemäß unseren Anweisungen eingesetzt werden;
- 03 sont conformes à (aux normes) ou autres) document(s) normatifs, pour autant qu'ils soient utilisés conformément à nos instructions;
- 04 conform de (volgende normen) / één of meer andere bindende documenten zijn, op voorwaarde dat ze worden gebruikt overeenkomstig onze instructies;
- 05 están en conformidad con (las) siguiente(s) norma(s) u otro(s) documento(s) normativo(s), siempre que sean utilizados de acuerdo con nuestras instrucciones;
- 06 sono conformi alle) seguente(i) standard(i) o altro(i) document(i) a carattere normativo, a patto che vengano usati in conformità alle nostre istruzioni;
- 07 είναι σύμφωνα με το(α) ακόλουθο(α) πρότυπο(α) ή άλλο(α) έγγραφο(α) κανονιστικό, υπό την προϋπόθεση ότι χρησιμοποιείται σύμφωνα με τις οδηγίες μας;

EN60335-2-40,

- 01 gemäß den Vorschriften der; 19 (de) uođielazjege af bestemmelserne i;
- 02 conformément aux stipulations des; 20 (fr) underlagte af bestemmelserne i;
- 03 overeenkomstig de bepalingen van; 21 (nl) enligt villkoren i;
- 04 segundo las disposiciones de; 22 (es) creșterea răspunsului la;
- 05 secondo le prescrizioni per; 23 (it) lakaitis nustatė, pateikiami;
- 06 de acuerdo con el previso etc. 24 (de) držitelji uporabni priročniki;
- 07 (de) in Übereinstimmung mit; 25 (hr) kvaeti odabana;
- 08 (de) in Übereinstimmung mit; 26 (hr) kvaeti odabana;
- 09 (de) in Übereinstimmung mit; 27 (de) zgodne z postopnjeniami Direktivy;
- 10 (de) in Übereinstimmung mit; 28 (de) in Übereinstimmung mit;

**Low Voltage 2014/35/EU
Electromagnetic Compatibility 2014/30/EU**

- 11 Informatorion* enigi <A> och godkants av enligt Certifikat <C>.
- 12 Merk* sommet i tekenomet r <A> og gjennoms positiv bestemelse av ifølge Sertifika <C>.
- 13 Huon* jotta on esittely asiakirjassa <A> ja jotta on hyväksytty Sertifikaatin <C> mukaisesti.
- 14 Poznámka* jak bylo uvedeno v <A> a pozitivně zjištěno pešení souhlasí s ověřením <C>.
- 15 Napomena* kako je izloženo u <A> pozitivno ovdjeđeno od strane prema Certifikatu <C>.
- 16 Megjegyzés* a(z) <A> alapján a(z) igazolta a megfelelést, a(z) <C> tanúsítvány szerinti.
- 17 Uvege* zgodnie z dokumentacją <A> pozytywną opinią i Swiadectwem <C>.
- 18 Nót* az a című előírásokban <A> és a pozitív állásfoglalásban megadottaknak megfelelően <C> tanúsítvány alapján.
- 19 Obavještenje* kako je izloženo u <A> pozitivno ovdjeđeno od strane prema Certifikatu <C>.
- 20 Napomena* kako je izloženo u <A> pozitivno ovdjeđeno od strane prema Certifikatu <C>.
- 21 Zabeleška* kako je izloženo u <A> i ovdjeđeno pozitivno od prema Certifikatu <C>.
- 22 Pastaba* pažnja: u ovom slučaju u <A> je navedeno pozitivno mišljenje o konformnosti sa pozitivno izdatim <C> sertifikatom.
- 23 Pízišmes* jak bylo uvedeno v <A> a pozitivně zjištěno pešení souhlasí s ověřením <C>.
- 24 Poznámka* jak bylo uvedeno v <A> a pozitivně zjištěno pešení souhlasí s ověřením <C>.
- 25 Nót* megjegyzés: a(z) <A> alapján a(z) igazolta a megfelelést, a(z) <C> tanúsítvány szerinti.

- 01 Directives as amended; 10 Direktiver, med senere ændringer;
- 02 Direktiven, i de ændrede udgaver; 11 Direktive, med frelagna ändringar;
- 03 Direktiven, i de ændrede udgaver; 12 Direktive, med foretagne ændringer;
- 04 Richtlijnen, zoals gewijzigd; 13 Direktive, selaisna kuin ne ovat muutettuna;
- 05 Richtlinien, zoals gewijzigd; 14 v ríadnách zmeň;
- 06 Directives, come da modifica; 15 Spriegums, kaio je izmēģinēti;
- 07 Obavještenje* kako je izloženo u <A> i ovdjeđeno pozitivno od prema Certifikatu <C>.
- 08 Directives, conforme à la version révisée; 16 irányelvék) és módosítások rendelkezései;
- 09 Direktiven, i de ændrede udgaver; 17 z piznesprijm) popravkami;
- 10 Direktiver, med senere ændringer; 18 Direktiver, cu amendamentele respective;
- 11 Direktive, med foretagne ændringer; 19 Direktive z usmi spremembami;
- 12 Direktive, med foretagne ændringer; 20 Direktivd koos muudatustega;
- 13 Direktive, selaisna kuin ne ovat muutettuna; 21 Direktivek, s reuvaria ralevenien;
- 14 v ríadnách zmeň; 22 Direktivosa su parprijmams;
- 15 Spriegums, kaio je izmēģinēti; 23 Direktivās un to papildinājumus;
- 16 irányelvék) és módosítások rendelkezései; 24 Smerenies, i platom mesit;
- 17 z piznesprijm) popravkami; 25 Dajštinings ialeitje) Ioneimeleker;

- 16 megjelölések az alábbi szabvány(ok)nak vagy egyéb tárgyalt dokumentum(ok)nak, az azokat előírtak szerint használják;
- 17 szerint a következő normatív (normatív) dokumentum(ok)mal, amiket a használatukhoz szükséges utasításokkal együtt kell használni;
- 18 megfelelnek az alábbi szabvány(ok)nak vagy egyéb tárgyalt dokumentum(ok)nak, az azokat előírtak szerint használják;
- 19 sprijm) u normatív) (normatív) dokumentum) (normatív) (su) atle) (dokument) (normatív), cu condiția ca acestea să fie utilizate în conformitate cu instrucțiunile noastre;
- 20 on vastavuse järgmis)le standard)ile (ja või teise normatiivsele dokumend)ile, kui need kasutatakse vastavalt meie juhend)ele;
- 21 odgovaraat na odredbe stavar)ni ili drugi) normativni dokument, pri upotrebi, kad se koristeat u skladu s našim instrukcijama;
- 22 atlika žemai nurodyti) standart)ai (ar)ba kit) norminami dokument)ai su sąlyga, kad yra naudojami pagal mūsų nurodymus;
- 23 tad, ja tebi) atbilst)ti) razložiti) n)rdaj)im)am, abisi) sk) goš)em) sprijm)en)im) un o)leim) normatiiv)ni) dokument)im);
- 24 su i) z)robie s nasledov)ni)mi) normatiiv)ni) (dokument)im)ai), za predpokladi, že sa použív)ajú v s)lade s našim) navod)mi;
- 25 i)ur)in, i)atmaln)ma)z) g)re) k)l)an)im)asi) koš)ul)ia) as)g)u)di)ki) standard)ar) ve) norm) be)l)iten) be)l)eg)erie) u)ym)ul)adi);

DAIKIN EUROPE N.V.
Zandvoordstraat 300, B-8400 Oostende, Belgium



Hiroimitsu Iwasaki
Director
Ostend, 1st of October 2021

Table of contents

1	About the documentation	3	7.4.1	Main zone	28
1.1	About this document.....	3	7.4.2	Additional zone	28
2	Specific installer safety instructions	4	7.4.3	Information	29
3	About the box	5	7.5	Menu structure: Overview installer settings.....	30
3.1	Indoor unit	5	8	Commissioning	31
3.1.1	To remove the accessories from the indoor unit.....	5	8.1	Checklist before commissioning.....	31
4	Unit installation	5	8.2	Checklist during commissioning.....	31
4.1	Preparing the installation site	5	8.2.1	To check the minimum flow rate	32
4.1.1	Installation site requirements of the indoor unit	5	8.2.2	To perform an air purge	32
4.2	Opening and closing the unit.....	6	8.2.3	To perform an operation test run	32
4.2.1	To open the indoor unit	6	8.2.4	To perform an actuator test run	32
4.2.2	To close the indoor unit.....	6	8.2.5	To perform an underfloor heating screed dryout.....	32
4.3	Mounting the indoor unit.....	7	9	Hand-over to the user	33
4.3.1	To install the indoor unit.....	7	10	Technical data	34
4.3.2	To connect the drain hose to the drain	7	10.1	Piping diagram: Indoor unit	34
5	Piping installation	7	10.2	Wiring diagram: Indoor unit	35
5.1	Preparing water piping	7	1	About the documentation	
5.1.1	To check the water volume and flow rate	8	1.1	About this document	
5.1.2	Third-party tank requirements.....	8	Target audience		
5.2	Connecting water piping.....	8	Authorised installers		
5.2.1	To connect the water piping.....	8	Documentation set		
5.2.2	To fill the water circuit	9	This document is part of a documentation set. The complete set consists of:		
5.2.3	To protect the water circuit against freezing	9	▪ General safety precautions:		
5.2.4	To fill the domestic hot water tank	10	▪ Safety instructions that you must read before installing		
5.2.5	To insulate the water piping	10	▪ Format: Paper (in the box of the indoor unit)		
6	Electrical installation	10	▪ Operation manual:		
6.1	About electrical compliance.....	10	▪ Quick guide for basic usage		
6.2	Guidelines when connecting the electrical wiring.....	10	▪ Format: Paper (in the box of the indoor unit)		
6.3	Connections to the indoor unit.....	11	▪ User reference guide:		
6.3.1	To connect the main power supply	12	▪ Detailed step-by-step instructions and background information for basic and advanced usage		
6.3.2	To connect the backup heater power supply	13	▪ Format: Digital files on http://www.daikineurope.com/support-and-manuals/product-information/		
6.3.3	To connect the shut-off valve.....	15	▪ Installation manual – Outdoor unit:		
6.3.4	To connect the electricity meters	15	▪ Installation instructions		
6.3.5	To connect the domestic hot water pump	15	▪ Format: Paper (in the box of the outdoor unit)		
6.3.6	To connect the alarm output	16	▪ Installation manual – Indoor unit:		
6.3.7	To connect the space cooling/heating ON/OFF output.....	16	▪ Installation instructions		
6.3.8	To connect the changeover to external heat source... ..	17	▪ Format: Paper (in the box of the indoor unit)		
6.3.9	To connect the power consumption digital inputs	17	▪ Installer reference guide:		
6.3.10	To connect the safety thermostat (normally closed contact)	18	▪ Preparation of the installation, good practices, reference data, ...		
6.3.11	To connect a Smart Grid.....	18	▪ Format: Digital files on http://www.daikineurope.com/support-and-manuals/product-information/		
6.3.12	To connect the WLAN cartridge (delivered as accessory).....	20	▪ Addendum book for optional equipment:		
7	Configuration	21	▪ Additional info about how to install optional equipment		
7.1	Overview: Configuration	21	▪ Format: Paper (in the box of the indoor unit) + Digital files on http://www.daikineurope.com/support-and-manuals/product-information/		
7.1.1	To access the most used commands	21	Latest revisions of the supplied documentation may be available on the regional Daikin website or via your dealer.		
7.2	Configuration wizard.....	22			
7.2.1	Configuration wizard: Language	22			
7.2.2	Configuration wizard: Time and date	22			
7.2.3	Configuration wizard: System	22			
7.2.4	Configuration wizard: Backup heater.....	24			
7.2.5	Configuration wizard: Main zone.....	24			
7.2.6	Configuration wizard: Additional zone.....	25			
7.2.7	Configuration wizard: Tank	26			
7.3	Weather-dependent curve.....	26			
7.3.1	What is a weather-dependent curve?	26			
7.3.2	2-points curve	26			
7.3.3	Slope-offset curve	27			
7.3.4	Using weather-dependent curves	27			
7.4	Settings menu	28			

2 Specific installer safety instructions

The original documentation is written in English. All other languages are translations.

Technical engineering data

- A **subset** of the latest technical data is available on the regional Daikin website (publicly accessible).
- The **full set** of latest technical data is available on the Daikin Business Portal (authentication required).

Online tools

In addition to the documentation set, some online tools are available for installers:

- **Daikin Technical Data Hub**
 - Central hub for technical specifications of the unit, useful tools, digital resources, and more.
 - Publicly accessible via <https://daikintechdatahub.eu>.
- **Heating Solutions Navigator**
 - Digital toolbox that offers a variety of tools to facilitate the installation and configuration of heating systems.
 - To access Heating Solutions Navigator, registration to the Stand By Me platform is required. For more information, see <https://professional.standbyme.daikin.eu>.
- **Daikin e-Care**
 - Mobile app for installers and service technicians that allows you to register, configure and troubleshoot heating systems.
 - The mobile app can be downloaded for iOS and Android devices using the QR codes below. Registration to the Stand By Me platform is required to access the app.

App Store

Google Play



2 Specific installer safety instructions

Always observe the following safety instructions and regulations.

Opening and closing the unit (see "[4.2 Opening and closing the unit](#)" ▶ 6)



DANGER: RISK OF ELECTROCUTION



DANGER: RISK OF BURNING/SCALDING

Mounting the indoor unit (see "[4.3 Mounting the indoor unit](#)" ▶ 7)



WARNING

Fixing method of the indoor unit **MUST** be in accordance with the instructions from this manual. See "[4.3 Mounting the indoor unit](#)" ▶ 7.

Piping installation (see "[5 Piping installation](#)" ▶ 7)



WARNING

Field piping method **MUST** be in accordance with the instructions from this manual. See "[5 Piping installation](#)" ▶ 7.



WARNING

Install the tundish away from any electrical device.
Possible consequence: Electrical shock or fire.

In case of freeze protection by glycol:



WARNING

Ethylene glycol is toxic.



WARNING

Due to the presence of glycol, corrosion of the system is possible. Uninhibited glycol will turn acidic under the influence of oxygen. This process is accelerated by the presence of copper and high temperatures. The acidic uninhibited glycol attacks metal surfaces and forms galvanic corrosion cells that cause severe damage to the system. Therefore it is important that:

- the water treatment is correctly executed by a qualified water specialist,
- a glycol with corrosion inhibitors is selected to counteract acids formed by the oxidation of glycols,
- no automotive glycol is used because their corrosion inhibitors have a limited lifetime and contain silicates which can foul or plug the system,
- galvanized pipes are **NOT** used in glycol systems since the presence may lead to the precipitation of certain components in the glycol's corrosion inhibitor.

Electrical installation (see "[6 Electrical installation](#)" ▶ 10)



DANGER: RISK OF ELECTROCUTION



WARNING

Electrical wiring connection method **MUST** be in accordance with the instructions from this manual. See "[6 Electrical installation](#)" ▶ 10.



WARNING

- All wiring **MUST** be performed by an authorised electrician and **MUST** comply with the applicable legislation.
- Make electrical connections to the fixed wiring.
- All components procured on-site and all electrical construction **MUST** comply with the applicable legislation.



WARNING

ALWAYS use multicore cable for power supply cables.



CAUTION

Do **NOT** push or place redundant cable length in the unit.



WARNING

The backup heater **MUST** have a dedicated power supply and **MUST** be protected by the safety devices required by the applicable legislation.



CAUTION

If the indoor unit has a tank with a built-in electrical booster heater, use a dedicated power circuit for the backup heater and booster heater. **NEVER** use a power circuit shared by another appliance. This power circuit **MUST** be protected with the required safety devices according to the applicable legislation.



CAUTION

To guarantee the unit is completely earthed, **ALWAYS** connect the backup heater power supply and the earth cable.

**WARNING**

Stripped wire. Make sure that stripped wire cannot make contact with possible water on the bottom plate.

**WARNING**

If the supply cord is damaged, it **MUST** be replaced by the manufacturer, its service agent or similarly qualified persons in order to avoid a hazard.

Commissioning (see "8 Commissioning" ▶ 31)

**WARNING**

Commissioning method **MUST** be in accordance with the instructions from this manual. See "8 Commissioning" ▶ 31.

3 About the box

3.1 Indoor unit

- At delivery, the unit **MUST** be checked for damage. Any damage **MUST** be reported immediately to the claims agent of the carrier.
- Bring the packed unit as close as possible to its final installation position to prevent damage during transport.
- Unpack the indoor unit completely according to the instructions mentioned on the unpacking instructions sheet.

3.1.1 To remove the accessories from the indoor unit

Some accessories are located inside the unit. For more information on opening the unit, see "4.2.1 To open the indoor unit" ▶ 6].

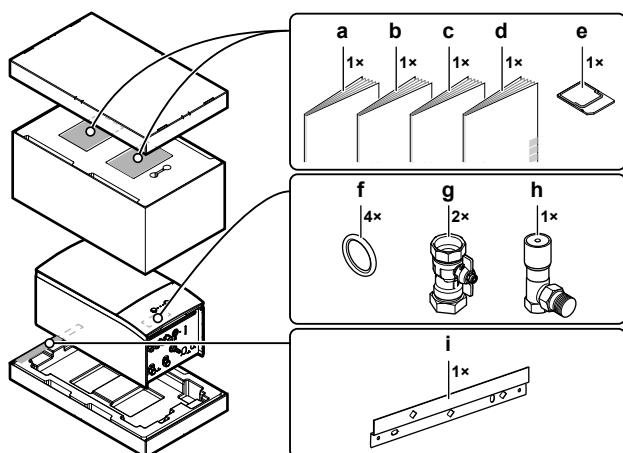

- a General safety precautions
- b Addendum book for optional equipment
- c Indoor unit installation manual
- d Operation manual
- e WLAN cartridge
- f Sealing ring for shut-off valve
- g Shut-off valve
- h Overpressure bypass valve
- i Wall bracket

4 Unit installation

4.1 Preparing the installation site

4.1.1 Installation site requirements of the indoor unit

- The indoor unit is designed for indoor installation only and for the following ambient temperatures:
 - Space heating operation: 5~30°C
 - Space cooling operation: 5~35°C
 - Domestic hot water production: 5~35°C

**INFORMATION**

Cooling is only applicable in case of:

- Reversible models
- Heating only models + conversion kit (EKHBCONV*)

- Mind the measurement guidelines:

Maximum height difference between indoor unit and outdoor unit	10 m
Maximum height difference between domestic hot water tank and outdoor unit	10 m
Maximum water piping length between indoor unit and domestic hot water tank	10 m
Maximum distance between the 3-way valve and the indoor unit (for installations with domestic hot water tank)	3 m
Maximum total water piping length ^(a) when using 1" piping	20 m ^(b) (single run)
Maximum total water piping length ^(a) when using 1 ¼" piping	50 m ^(b) (single run)

^(a) Between indoor unit and outdoor unit.

^(b) Precise water piping length can be determined using the Hydronic Piping Calculation tool. The Hydronic Piping Calculation tool is part of the Heating Solutions Navigator which can be reached via <https://professional.standby.me.daikin.eu>. Please contact your dealer if you have no access to Heating Solutions Navigator.

- Mind the following spacing installation guidelines:

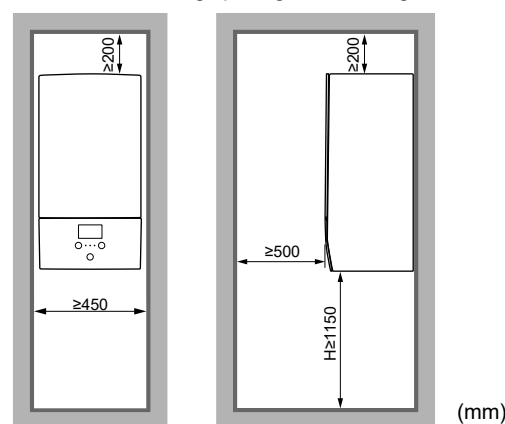

H Height measured from the bottom of the casing to the floor

4 Unit installation

4.2 Opening and closing the unit

4.2.1 To open the indoor unit

Overview

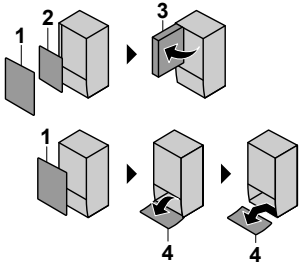

- 1 Front panel
- 2 Switch box cover
- 3 Switch box
- 4 User interface panel

Open

- 1 Remove the front panel.

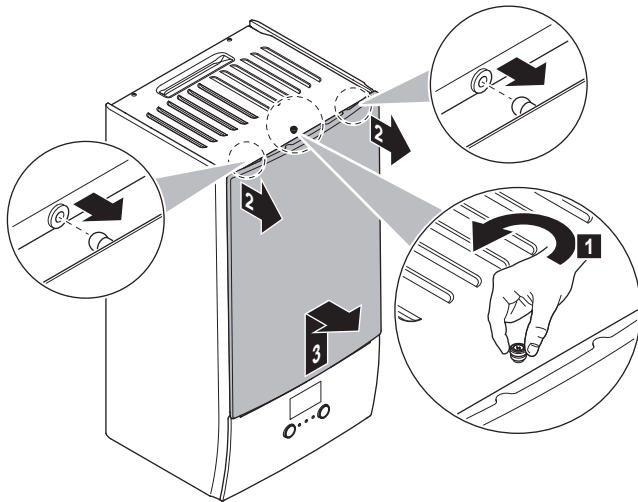

- 2 If you have to connect electrical wiring, remove the switch box cover.

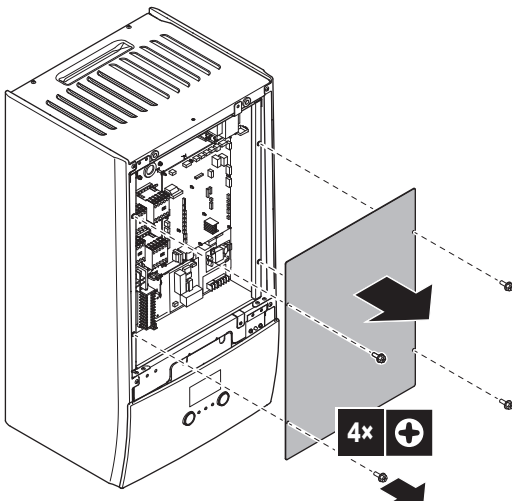

- 3 If you have to do work behind the switch box, open the switch box.

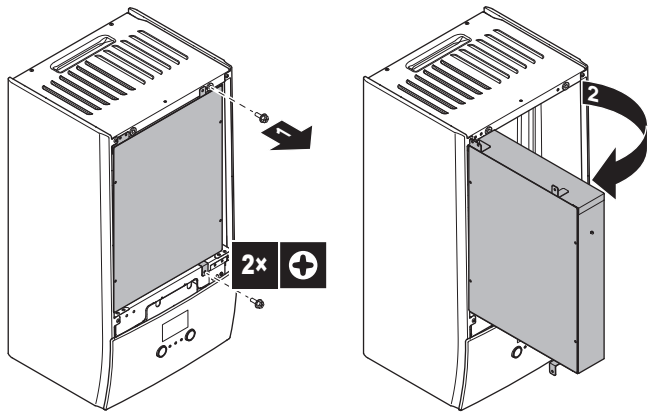

- 4 If you have to do work behind the user interface panel or upload new software into the user interface, open the user interface panel.

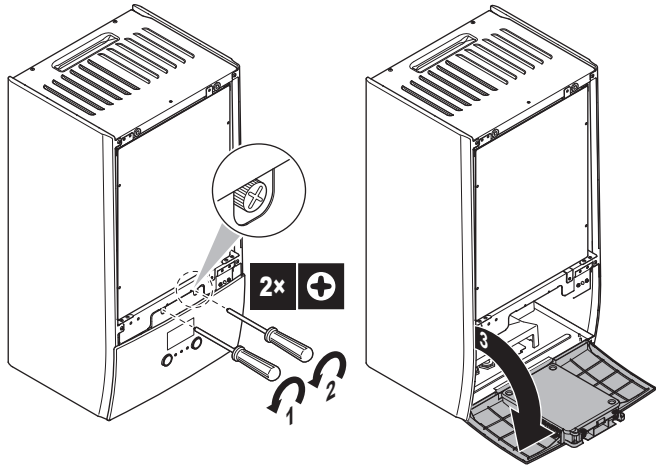

- 5 Optional: Remove the user interface panel.



NOTICE

If you remove the user interface panel, also disconnect the cables from the back of the user interface panel to prevent damage.

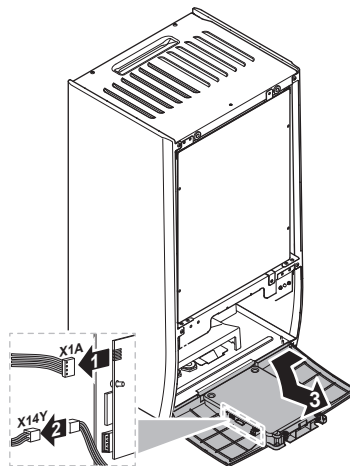

4.2.2 To close the indoor unit

- 1 Reinstall the user interface panel.
- 2 Reinstall the switch box cover and close the switch box.
- 3 Reinstall the front panel.



NOTICE

When closing the indoor unit cover, make sure that the tightening torque does NOT exceed 4.1 N•m.

4.3 Mounting the indoor unit

4.3.1 To install the indoor unit

- 1 Fix the wall bracket (accessory) to the wall (level) with 2× Ø8 mm bolts.

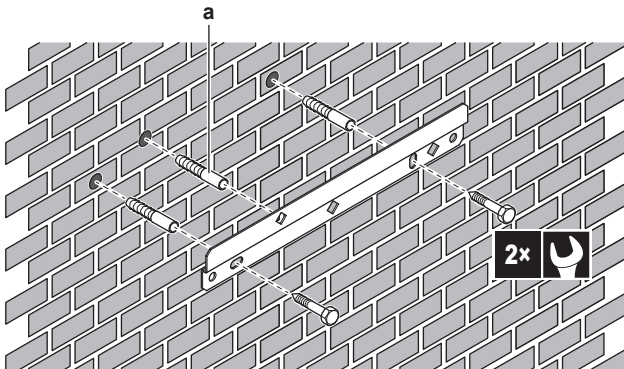

a Optional: If you want to fix the unit to the wall from inside the unit, provide an additional screw plug.

- 2 Lift the unit.

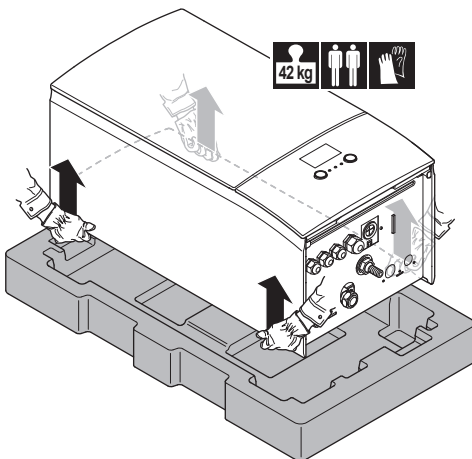

- 3 Attach the unit to the wall bracket:

- Tilt the top of the unit against the wall at the position of the wall bracket.
- Slide the bracket on the back of the unit over the wall bracket. Make sure the unit is fixed properly.

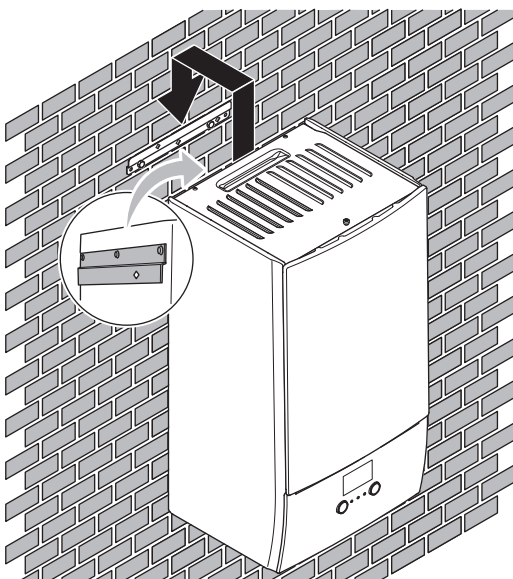

- 4 Optional: If you want to fix the unit to the wall from inside the unit:

- Remove the upper front panel, and open the switch box. See "4.2.1 To open the indoor unit" [p 6].
- Fix the unit to the wall with an Ø8 mm screw.

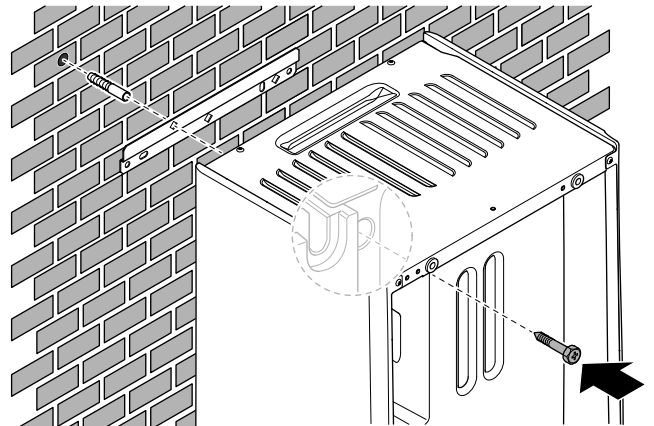

4.3.2 To connect the drain hose to the drain

Water coming from the pressure relief valve is collected in the drain pan. You must connect the drain pan to an appropriate drain according to the applicable legislation.

- 1 Connect a drain tube (field supply) to the drain pan connector as follows:

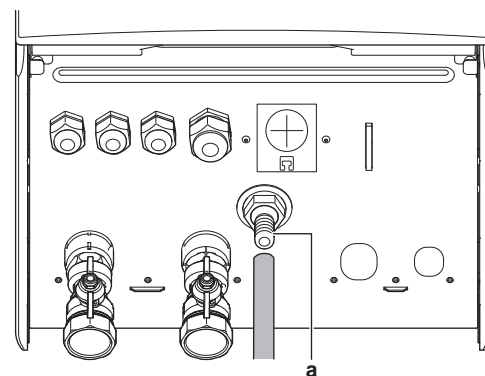

a Drain pan connector

It is recommended to use a tundish to collect the water.

5 Piping installation

5.1 Preparing water piping



NOTICE

In case of plastic pipes, make sure they are fully oxygen diffusion tight according to DIN 4726. The diffusion of oxygen into the piping can lead to excessive corrosion.



NOTICE

Water circuit requirements. Make sure to comply with the water pressure and water temperature requirements below. For additional water circuit requirements, see the installer reference guide.

- **Water pressure – Space heating/cooling circuit.** The maximum water pressure is 3 bar. Provide adequate safeguards in the water circuit to ensure that the maximum pressure is NOT exceeded. The minimum water pressure to operate is 1 bar.

5 Piping installation

- **Water temperature.** All installed piping and piping accessories (valve, connections,...) MUST withstand the following temperatures:

i INFORMATION

The following illustration is an example and might NOT match your system layout.

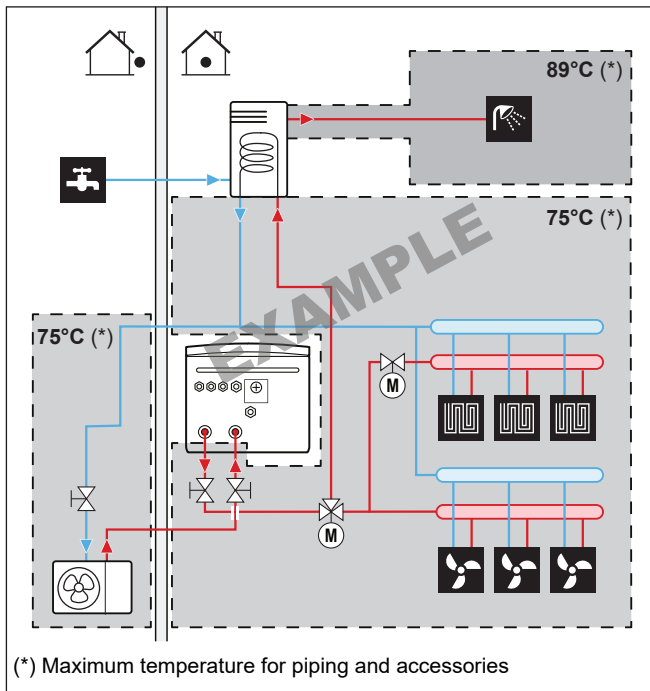

5.1.1 To check the water volume and flow rate

To make sure that the unit operates properly:

- You MUST check the minimum water volume and the minimum flow rate.

Minimum water volume

Check that the total water volume in the installation is minimum 20 litres, the internal water volume of the outdoor unit NOT included.

! NOTICE

When circulation in each space heating/cooling loop is controlled by remotely controlled valves, it is important that the minimum water volume is guaranteed, even if all of the valves are closed.

Minimum flow rate

Check that the minimum flow rate in the installation is guaranteed in all conditions. This minimum flow rate is required during defrost/backup heater operation. For this purpose, use the overpressure bypass valve delivered with the unit, and respect the minimum water volume.

Minimum required flow rate

20 l/min

! NOTICE

If glycol was added to the water circuit, and the temperature of the water circuit is low, the flow rate will NOT be displayed on the user interface. In this case, the minimum flow rate can be checked by way of the pump test (check that the user interface does NOT display error 7H).

! NOTICE

When circulation in each or certain space heating loops is controlled by remotely controlled valves, it is important that the minimum flow rate is guaranteed, even if all valves are closed. In case the minimum flow rate cannot be reached, a flow error 7H will be generated (no heating or operation).

See the installer reference guide for more information.

See the recommended procedure as described in "8.2 Checklist during commissioning" [▶ 31].

5.1.2 Third-party tank requirements

In case of a third-party tank, the tank shall adhere to the following requirements:

- The heat exchanger coil of the tank is $\geq 1.05 \text{ m}^2$.
- The tank thermistor must be located above the heat exchanger coil.
- The booster heater must be located above the heat exchanger coil.

! NOTICE

Performance. Performance data for third-party tanks CANNOT be provided, and performance CANNOT be guaranteed.

! NOTICE

Configuration. Configuration of a third-party tank depends on the size of the heat exchanger coil of the tank. For more information, see the installer reference guide.

5.2 Connecting water piping

5.2.1 To connect the water piping

! NOTICE

Do NOT use excessive force when connecting the field piping and make sure the piping is aligned properly. Deformation of the piping can cause malfunctioning of the unit.

! NOTICE

Do NOT use excessive force when connecting the piping. Deformation of the piping can cause malfunctioning of the unit.

- 1 Connect the O-rings and shut-off valves to the indoor unit water connections.
- 2 Connect the outdoor unit field piping on the water IN connection (a) of the indoor unit.
- 3 Connect the space heating/cooling field piping on the space heating water OUT connection (b) of the indoor unit.

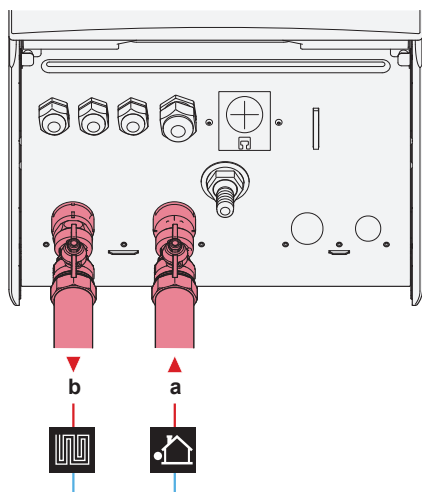

a Water IN (screw connection, 1")
b Space heating water OUT (screw connection, 1")

NOTICE



Overpressure bypass valve (delivered as accessory). We recommend to install the overpressure bypass valve in the space heating water circuit.

- Mind the minimum water volume when choosing the installation location of the overpressure bypass valve (at the indoor unit, or at the collector). See "[5.1.1 To check the water volume and flow rate](#)" [8].
- Mind the minimum flow rate when adjusting the overpressure bypass valve setting. See "[5.1.1 To check the water volume and flow rate](#)" [8] and "[8.2.1 To check the minimum flow rate](#)" [32].

NOTICE

Install air purge valves at all local high points.

NOTICE

In case an optional domestic hot water tank is installed: A pressure relief valve (field supply) with an opening pressure of maximum 10 bar (= 1 MPa) must be installed on the domestic cold water inlet connection in accordance with the applicable legislation.

5.2.2 To fill the water circuit

To fill the water circuit, use a field supply filling kit. Make sure you comply with the applicable legislation.

NOTICE

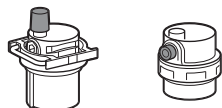

Make sure both air purge valves (one on the magnetic filter and one on the backup heater) are open.

All automatic air purge valves **MUST** remain open after commissioning.

5.2.3 To protect the water circuit against freezing

About freeze protection

Frost can damage the system. To prevent the hydraulic components from freezing, the software is equipped with special frost protection functions such as water pipe freeze prevention and drain prevention (see the installer reference guide) that include the activation of pump in case of low temperatures.

However, in case of a power failure, these functions cannot guarantee protection.

Do one of the following to protect the water circuit against freezing:

- Add glycol to the water. Glycol lowers the freezing point of the water.
- Install freeze protection valves. Freeze protection valves drain the water from the system before it can freeze. Insulate the freeze protection valves in a similar way as the water piping, but do NOT insulate the inlet and outlet (release) of these valves.

NOTICE

If you add glycol to the water, do NOT install freeze protection valves. **Possible consequence:** Glycol leaking out of the freeze protection valves.

Freeze protection by glycol

About freeze protection by glycol

Adding glycol to the water lowers the freezing point of water.

WARNING

Ethylene glycol is toxic.

WARNING

Due to the presence of glycol, corrosion of the system is possible. Uninhibited glycol will turn acidic under the influence of oxygen. This process is accelerated by the presence of copper and high temperatures. The acidic uninhibited glycol attacks metal surfaces and forms galvanic corrosion cells that cause severe damage to the system. Therefore it is important that:

- the water treatment is correctly executed by a qualified water specialist,
- a glycol with corrosion inhibitors is selected to counteract acids formed by the oxidation of glycols,
- no automotive glycol is used because their corrosion inhibitors have a limited lifetime and contain silicates which can foul or plug the system,
- galvanized pipes are NOT used in glycol systems since the presence may lead to the precipitation of certain components in the glycol's corrosion inhibitor.

NOTICE

Glycol absorbs water from its environment. Therefore do NOT add glycol that has been exposed to air. Leaving the cap off the glycol container causes the concentration of water to increase. The glycol concentration is then lower than assumed. As a result, the hydraulic components might freeze up after all. Take preventive actions to ensure a minimal exposure of the glycol to air.

Types of glycol

The types of glycol that can be used depend on whether the system contains a domestic hot water tank:

6 Electrical installation

If...	Then...
The system contains a domestic hot water tank	Only use propylene glycol ^(a)
The system does NOT contain a domestic hot water tank	You can use either propylene glycol ^(a) or ethylene glycol

^(a) Propylene glycol, including the necessary inhibitors, classified as Category III according to EN1717.

Required concentration of glycol

The required concentration of glycol depends on the lowest expected outdoor temperature, and on whether you want to protect the system from bursting or from freezing. To prevent the system from freezing, more glycol is required.

Add glycol according to the table below.

Lowest expected outdoor temperature	Prevent from bursting	Prevent from freezing
-5°C	10%	15%
-10°C	15%	25%
-15°C	20%	35%
-20°C	25%	—
-25°C	30%	—
-30°C	35%	—



INFORMATION

- Protection against bursting: the glycol will prevent the piping from bursting, but NOT the liquid inside the piping from freezing.
- Protection against freezing: the glycol will prevent the liquid inside the piping from freezing.



NOTICE

- The required concentration might differ depending on the type of glycol. ALWAYS compare the requirements from the table above with the specifications provided by the glycol manufacturer. If necessary, meet the requirements set by the glycol manufacturer.
- The added concentration of glycol should NEVER exceed 35%.
- If the liquid in the system is frozen, the pump will NOT be able to start. Mind that if you only prevent the system from bursting, the liquid inside might still freeze.
- When water is at standstill inside the system, the system is very likely to freeze and get damaged.

Glycol and the maximum allowed water volume

Adding glycol to the water circuit reduces the maximum allowed water volume of the system. For more information, see the installer reference guide (topic "To check the water volume and flow rate").

Glycol setting



NOTICE

If glycol is present in the system, setting [E-0D] must be set to 1. If the glycol setting is NOT set correctly, the liquid inside the piping can freeze.

Freeze protection by freeze protection valves

About freeze protection valves

When no glycol is added to the water, you can use freeze protection valves to drain the water from the system before it can freeze.

- Install freeze protection valves (field supply) at all lowest points of the field piping.

- Normally closed valves (located indoors near the piping entry/exit points) can prevent that all water from indoor piping is drained when the freeze protection valves open.



NOTICE

When freeze protection valves are installed, set the minimum cooling setpoint (default=7°C) at least 2°C higher than the maximum opening temperature of the freeze protection valve. If lower, freeze protection valves can open during cooling operation.

For more information, see the installer reference guide.

5.2.4 To fill the domestic hot water tank

See the installation manual of the domestic hot water tank.

5.2.5 To insulate the water piping

The piping in the complete water circuit MUST be insulated to prevent condensation during cooling operation and reduction of the heating and cooling capacity.

Outdoor water piping insulation

See the installation manual of the outdoor unit, or the installer reference guide.

6 Electrical installation



DANGER: RISK OF ELECTROCUTION



WARNING

ALWAYS use multicore cable for power supply cables.



WARNING

If the supply cord is damaged, it MUST be replaced by the manufacturer, its service agent or similarly qualified persons in order to avoid a hazard.



INFORMATION

When installing field supply or option cables, foresee sufficient cable length. This will make it possible to open the switch box and gain access to other components during service.



CAUTION

Do NOT push or place redundant cable length in the unit.



NOTICE

The distance between the high voltage and low voltage cables should be at least 50 mm.

6.1 About electrical compliance

Only for the backup heater of the indoor unit

See "6.3.2 To connect the backup heater power supply" ▶ 13].

6.2 Guidelines when connecting the electrical wiring



Tightening torques













Indoor unit:

Item	Tightening torque (N·m)
X1M	2.45 ±10%
X2M	0.88 ±10%



















Item	Tightening torque (N·m)
X5M	0.88 ±10%
X6M	2.45 ±10%
X7M, X8M	2.45 ±10%
X10M	0.88 ±10%
M4 (earth)	1.47 ±10%

6.3 Connections to the indoor unit

Item	Description
Power supply (main)	See "6.3.1 To connect the main power supply" [12].
Power supply (backup heater)	See "6.3.2 To connect the backup heater power supply" [13].
Shut-off valve	See "6.3.3 To connect the shut-off valve" [15].
Electricity meters	See "6.3.4 To connect the electricity meters" [15].
Domestic hot water pump	See "6.3.5 To connect the domestic hot water pump" [15].
Alarm output	See "6.3.6 To connect the alarm output" [16].
Space cooling/heating operation control	See "6.3.7 To connect the space cooling/heating ON/OFF output" [16].
Changeover to external heat source control	See "6.3.8 To connect the changeover to external heat source" [17].
Power consumption digital inputs	See "6.3.9 To connect the power consumption digital inputs" [17].
Safety thermostat	See "6.3.10 To connect the safety thermostat (normally closed contact)" [18].
Smart Grid	See "6.3.11 To connect a Smart Grid" [18].
WLAN cartridge	See "6.3.12 To connect the WLAN cartridge (delivered as accessory)" [20].
Room thermostat (wired or wireless)	 See below table.
	 Wires: 0.75 mm ² Maximum running current: 100 mA
	 For the main zone: <ul style="list-style-type: none"> ▪ [2.9] Control ▪ [2.A] Thermostat type For the additional zone: <ul style="list-style-type: none"> ▪ [3.A] Thermostat type ▪ [3.9] (read-only) Control

Item	Description
Heat pump convector	 There are different controllers and setups possible for the heat pump convectors. Depending on the setup, you also need to implement a relay (field supply, see addendum book for optional equipment). For more information, see: <ul style="list-style-type: none"> ▪ Installation manual of the heat pump convectors ▪ Installation manual of the heat pump convector options ▪ Addendum book for optional equipment
	 Wires: 0.75 mm ² Maximum running current: 100 mA
	 For the main zone: <ul style="list-style-type: none"> ▪ [2.9] Control ▪ [2.A] Thermostat type For the additional zone: <ul style="list-style-type: none"> ▪ [3.A] Thermostat type ▪ [3.9] (read-only) Control
Remote outdoor sensor	 See: <ul style="list-style-type: none"> ▪ Installation manual of the remote outdoor sensor ▪ Addendum book for optional equipment
	 Wires: 2×0.75 mm ²
	 [9.B.1]=1 (External sensor = Outdoor) [9.B.2] Ext. amb. sensor offset [9.B.3] Averaging time
Remote indoor sensor	 See: <ul style="list-style-type: none"> ▪ Installation manual of the remote indoor sensor ▪ Addendum book for optional equipment
	 Wires: 2×0.75 mm ²
	 [9.B.1]=2 (External sensor = Room) [1.7] Room sensor offset
Human Comfort Interface	 See: <ul style="list-style-type: none"> ▪ Installation and operation manual of the Human Comfort Interface ▪ Addendum book for optional equipment
	 Wires: 2×(0.75~1.25 mm ²) Maximum length: 500 m
	 [2.9] Control [1.6] Room sensor offset

6 Electrical installation

Item	Description
(in case of DHW tank) 3-way valve	 See: <ul style="list-style-type: none"> Installation manual of the 3-way valve Addendum book for optional equipment
	 Wires: 3×0.75 mm ² Maximum running current: 100 mA
	 [9.2] Domestic hot water
(in case of DHW tank) Domestic hot water tank thermistor	 See: <ul style="list-style-type: none"> Installation manual of the domestic hot water tank Addendum book for optional equipment
	 Wires: 2 The thermistor and connection wire (12 m) are delivered with the domestic hot water tank.
	 [9.2] Domestic hot water
(in case of DHW tank) Power supply for booster heater (from indoor unit to thermal protector of booster heater)	 See: <ul style="list-style-type: none"> Installation manual of the DHW tank Addendum book for optional equipment
	 Wires: (2+GND)×2.5 mm ²
	 [9.4] Booster heater
(in case of DHW tank) Power supply for booster heater (from mains to indoor unit)	 See: <ul style="list-style-type: none"> Installation manual of the domestic hot water tank Addendum book for optional equipment
	 Wires: 2+GND Maximum running current: 13 A
	 [9.4] Booster heater
WLAN module	 See: <ul style="list-style-type: none"> Installation manual of the WLAN module Addendum book for optional equipment Installer reference guide
	 Use the cable delivered with the WLAN module.
	 [D] Wireless gateway
Bizone kit	 See: <ul style="list-style-type: none"> Installation manual of the bizone kit Addendum book for optional equipment
	 Use the cable delivered with the bizone kit.
	 [9.P] Bizone kit

 for room thermostat (wired or wireless):

In case of...	See...
Wireless room thermostat	<ul style="list-style-type: none"> Installation manual of the wireless room thermostat Addendum book for optional equipment
Wired room thermostat without multi-zoning base unit	<ul style="list-style-type: none"> Installation manual of the wired room thermostat Addendum book for optional equipment
Wired room thermostat with multi-zoning base unit	<ul style="list-style-type: none"> Installation manual of the wired room thermostat (digital or analogue) + multi-zoning base unit Addendum book for optional equipment In this case: <ul style="list-style-type: none"> You need to connect the wired room thermostat (digital or analogue) to the multi-zoning base unit You need to connect the multi-zoning base unit to the outdoor unit For cooling/heating operation, you also need to implement a relay (field supply, see addendum book for optional equipment)

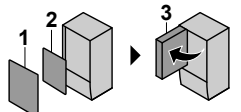

6.3.1 To connect the main power supply

- Open the following (see "4.2.1 To open the indoor unit" | 6):

1	Front panel	
2	Switch box cover	
3	Switch box	

- Connect the main power supply.

In case of normal kWh rate power supply

 Interconnection cable (= main power supply)	Wires: (3+GND)×1.5 mm ²
 —	

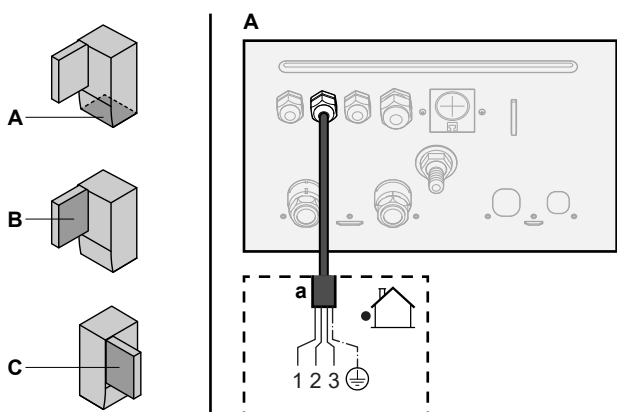

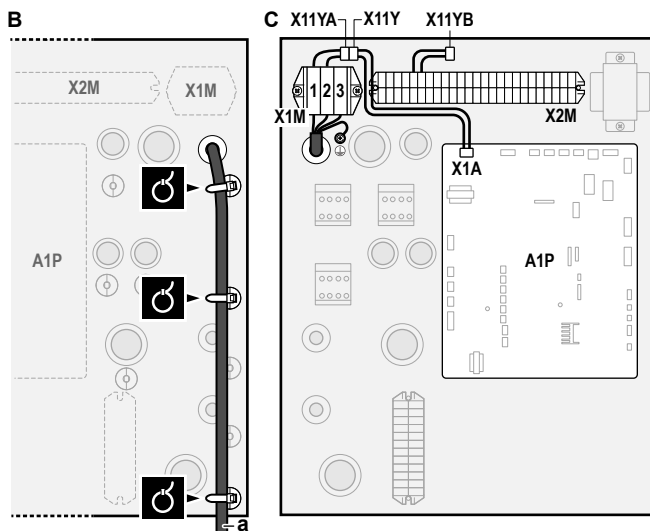

a Interconnection cable (=main power supply)

In case of preferential kWh rate power supply

	Interconnection cable (= main power supply)	Wires: (3+GND)×1.5 mm ²
	Normal kWh rate power supply	Wires: 1N Maximum running current: 6.3 A
	Preferential kWh rate power supply contact	Wires: 2×(0.75~1.25 mm ²) Maximum length: 50 m. Preferential kWh rate power supply contact: 16 V DC detection (voltage supplied by PCB). The voltage-free contact shall ensure the minimum applicable load of 15 V DC, 10 mA.
	[9.8] Benefit kWh power supply	

Connect X11Y to X11YB.

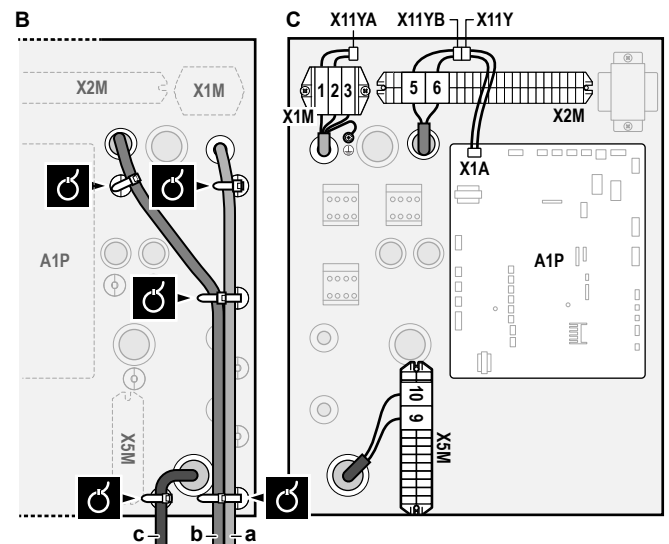
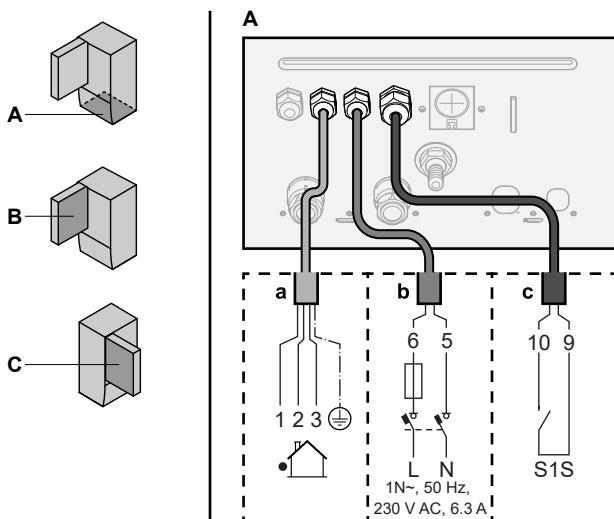

a Interconnection cable (=main power supply)
b Normal kWh rate power supply
c Preferential power supply contact

3 Fix the cables with cable ties to the cable tie mountings.

INFORMATION

In case of preferential kWh rate power supply, connect X11Y to X11YB. The necessity of separate normal kWh rate power supply to indoor unit (b) X2M/5+6 depends on the type of preferential kWh rate power supply.

Separate connection to the indoor unit is required:

- if preferential kWh rate power supply is interrupted when active, OR
- if no power consumption of the indoor unit is allowed at the preferential kWh rate power supply when active.

INFORMATION

The preferential kWh rate power supply contact is connected to the same terminals (X5M/9+10) as the safety thermostat. Thus, the system can have EITHER preferential kWh rate power supply OR a safety thermostat.

6.3.2 To connect the backup heater power supply

	Backup heater type	Power supply	Wires
	*6V	1N~ 230 V (6V3)	2+GND
		3~ 230 V (6T1)	3+GND
	*9W	3N~ 400 V	4+GND
	[9.3] Backup heater		

WARNING

The backup heater MUST have a dedicated power supply and MUST be protected by the safety devices required by the applicable legislation.

CAUTION

If the indoor unit has a tank with a built-in electrical booster heater, use a dedicated power circuit for the backup heater and booster heater. NEVER use a power circuit shared by another appliance. This power circuit MUST be protected with the required safety devices according to the applicable legislation.

6 Electrical installation

CAUTION

To guarantee the unit is completely earthed, ALWAYS connect the backup heater power supply and the earth cable.

The backup heater capacity can vary, depending on the indoor unit model. Make sure that the power supply is in accordance with the backup heater capacity, as listed in the table below.

Backup heater type	Backup heater capacity	Power supply	Maximum running current	Z _{max}
*6V	2 kW	1N~ 230 V ^(a)	9 A	—
	4 kW	1N~ 230 V ^(a)	17 A ^{(b)(c)}	0.22 Ω
	6 kW	1N~ 230 V ^(a)	26 A ^{(b)(c)}	0.22 Ω
	2 kW	3~ 230 V ^(d)	5 A	—
	4 kW	3~ 230 V ^(d)	10 A	—
*9W	3 kW	3N~ 400 V	4 A	—
	6 kW	3N~ 400 V	9 A	—
	9 kW	3N~ 400 V	13 A	—

^(a) 6V3

^(b) Electrical equipment complying with EN/IEC 61000-3-12 (European/International Technical Standard setting the limits for harmonic currents produced by equipment connected to public low-voltage systems with input current >16 A and ≤75 A per phase).

^(c) This equipment complies with EN/IEC 61000-3-11 (European/International Technical Standard setting the limits for voltage changes, voltage fluctuations and flicker in public low-voltage supply systems for equipment with rated current ≤75 A) provided that the system impedance Z_{sys} is less than or equal to Z_{max} at the interface point between the user's supply and the public system. It is the responsibility of the installer or user of the equipment to ensure, by consultation with the distribution network operator if necessary, that the equipment is connected only to a supply with a system impedance Z_{sys} less than or equal to Z_{max}.

^(d) 6T1

Connect the backup heater power supply as follows:

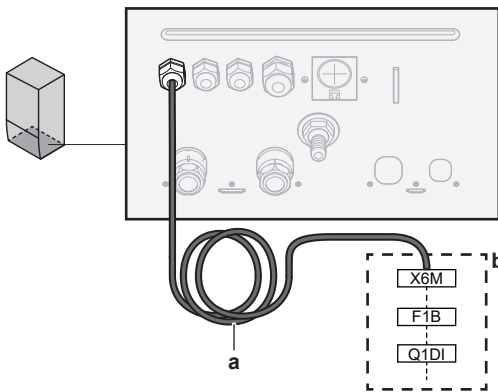

- a** Factory-mounted cable connected to the contactor of the backup heater, inside the switch box (K5M)
b Field wiring (see table below)

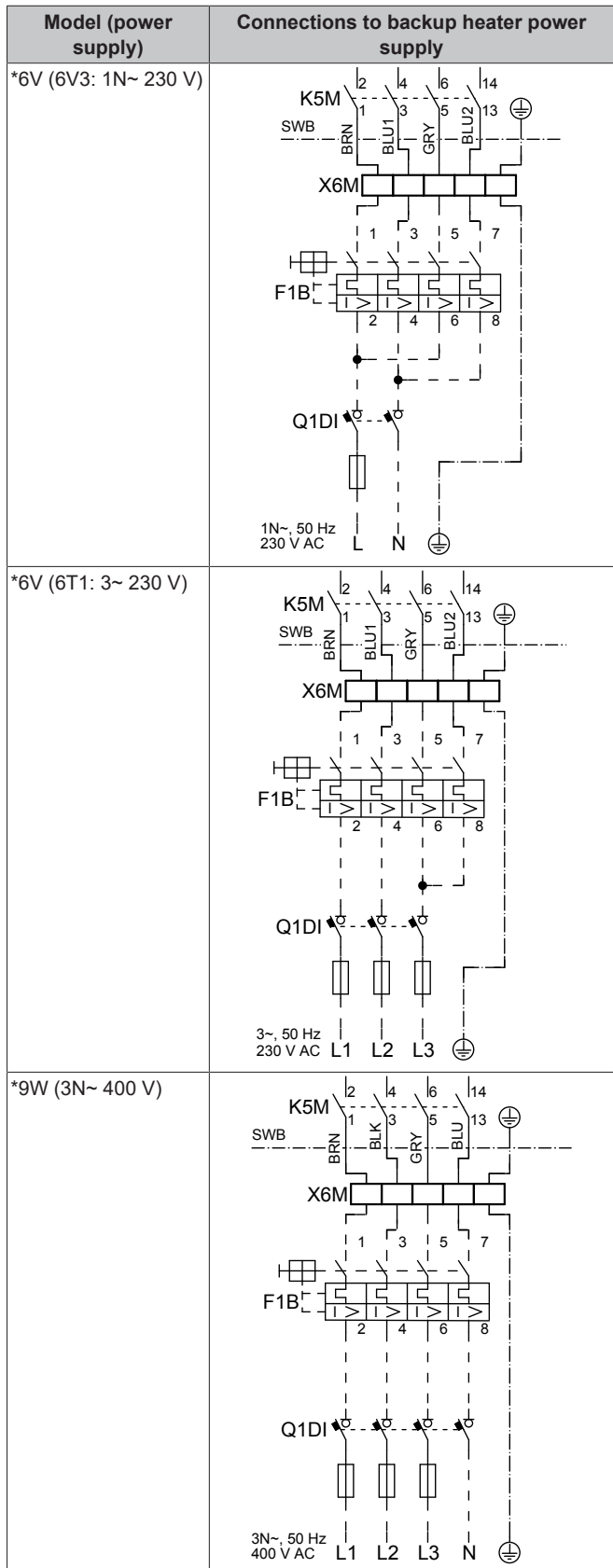

- F1B** Overcurrent fuse (field supply). Recommended fuse: 4-pole; 20 A; curve 400 V; tripping class C.
K5M Safety contactor (in the switch box)
Q1DI Earth leakage circuit breaker (field supply)
SWB Switch box
X6M Terminal (field supply)



NOTICE

Do NOT cut or remove the backup heater power supply cable.

6.3.3 To connect the shut-off valve



INFORMATION

Shut-off valve usage example. In case of one LWT zone, and a combination of underfloor heating and heat pump convectors, install a shut-off valve before the underfloor heating to prevent condensation on the floor during cooling operation. For more information, see the installer reference guide.



Wires: 2×0.75 mm²

Maximum running current: 100 mA

230 V AC supplied by PCB



[2.D] Shut off valve

- 1 Open the following (see "4.2.1 To open the indoor unit" ▸ 6):

1	Front panel
2	Switch box cover
3	Switch box

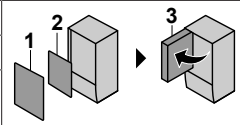

- 2 Connect the valve control cable to the appropriate terminals as shown in the illustration below.



NOTICE

Wiring is different for a NC (normally closed) valve and a NO (normally open) valve.

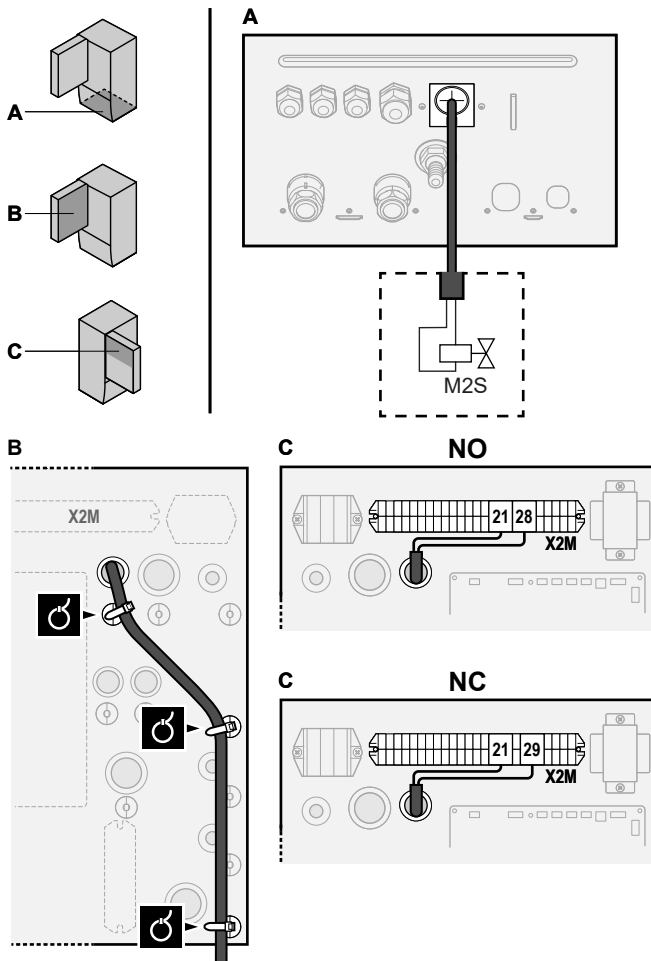

- 3 Fix the cable with cable ties to the cable tie mountings.

6.3.4 To connect the electricity meters



Wires: 2 (per meter)×0.75 mm²

Electricity meters: 12 V DC pulse detection (voltage supplied by PCB)



[9.A] Energy metering



INFORMATION

In case of an electricity meter with transistor output, check the polarity. The positive polarity MUST be connected to X5M/6 and X5M/4; the negative polarity to X5M/5 and X5M/3.

- 1 Open the following (see "4.2.1 To open the indoor unit" ▸ 6):

1	Front panel
2	Switch box cover
3	Switch box

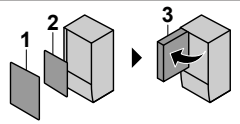

- 2 Connect the electricity meters cable to the appropriate terminals as shown in the illustration below.

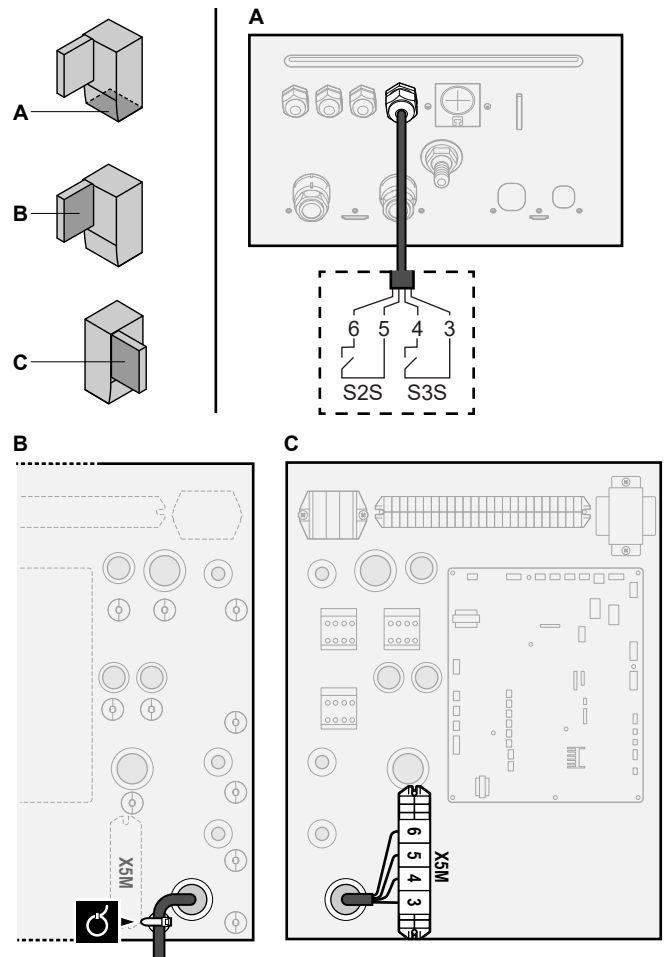

- 3 Fix the cable with cable ties to the cable tie mountings.

6.3.5 To connect the domestic hot water pump



Wires: (2+GND)×0.75 mm²

DHW pump output. Maximum load: 2 A (inrush), 230 V AC, 1 A (continuous)

6 Electrical installation

	[9.2.2] DHW pump [9.2.3] DHW pump schedule
--	---

1 Open the following (see "4.2.1 To open the indoor unit" ▸ 6):

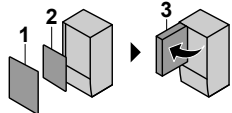

1	Front panel	
2	Switch box cover	
3	Switch box	

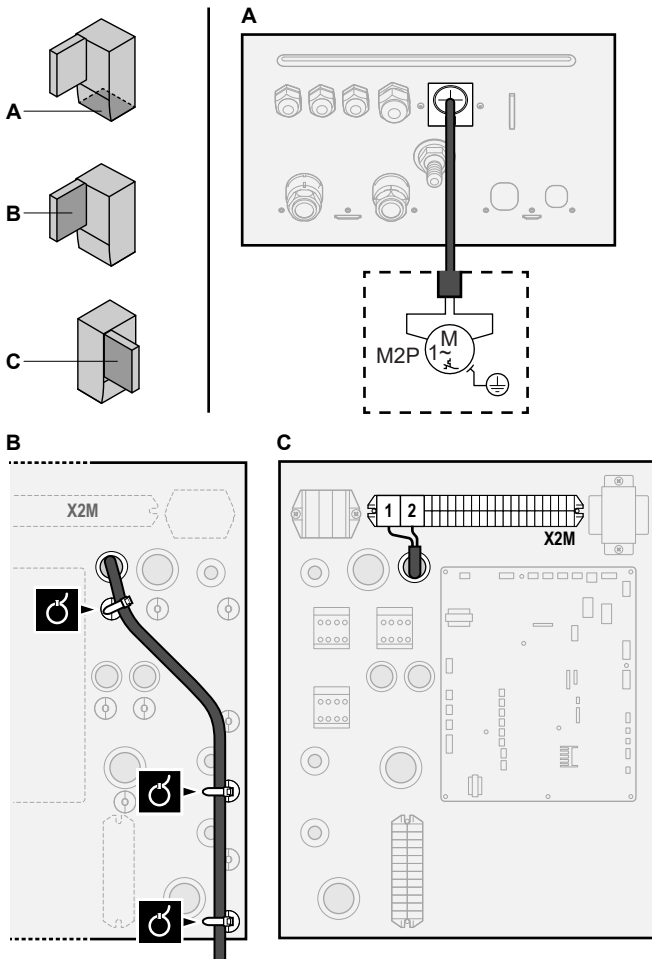
2 Connect the domestic hot water pump cable to the appropriate terminals as shown in the illustration below.



3 Fix the cable with cable ties to the cable tie mountings.

6.3.6 To connect the alarm output

	Wires: (2+1)×0.75 mm ² Maximum load: 0.3 A, 250 V AC
	[9.D] Alarm output

1 Open the following (see "4.2.1 To open the indoor unit" ▸ 6):

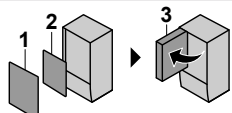
1	Front panel	
2	Switch box cover	
3	Switch box	

2 Connect the alarm output cable to the appropriate terminals as shown in the illustration below.

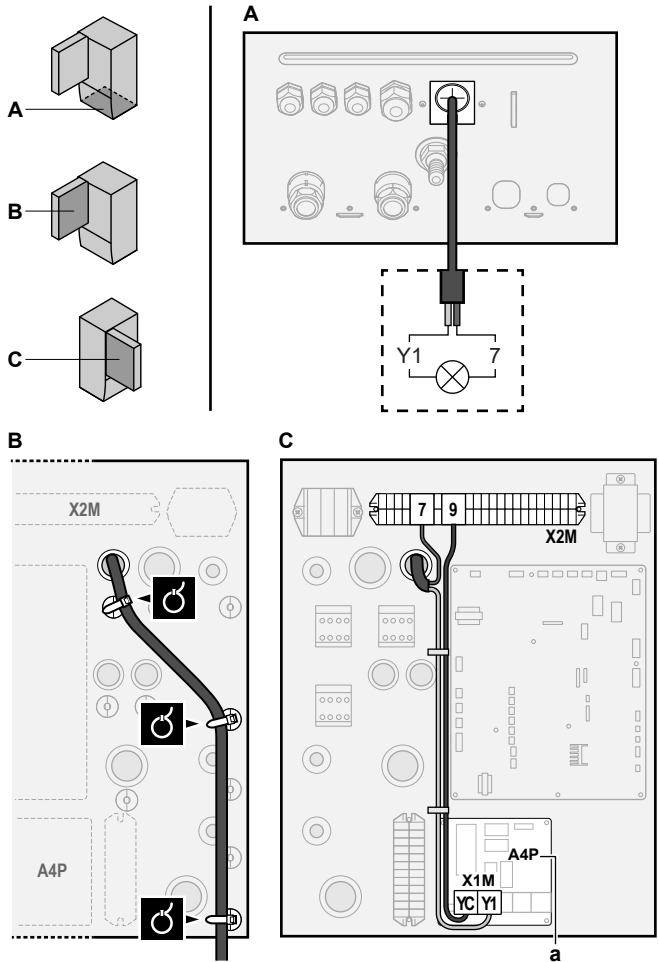
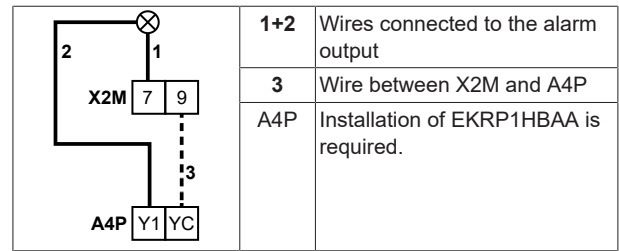

a Installation of EKR1HBAA is required.



3 Fix the cable with cable ties to the cable tie mountings.

6.3.7 To connect the space cooling/heating ON/OFF output

INFORMATION

Cooling is only applicable in case of:

- Reversible models
- Heating only models + conversion kit (EKHBCONV*)

	Wires: (2+1)×0.75 mm ² Maximum load: 0.3 A, 250 V AC
	—

1 Open the following (see "4.2.1 To open the indoor unit" ▸ 6):

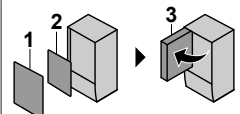
1	Front panel	
2	Switch box cover	
3	Switch box	

- 2 Connect the space cooling/heating ON/OFF output cable to the appropriate terminals as shown in the illustration below.

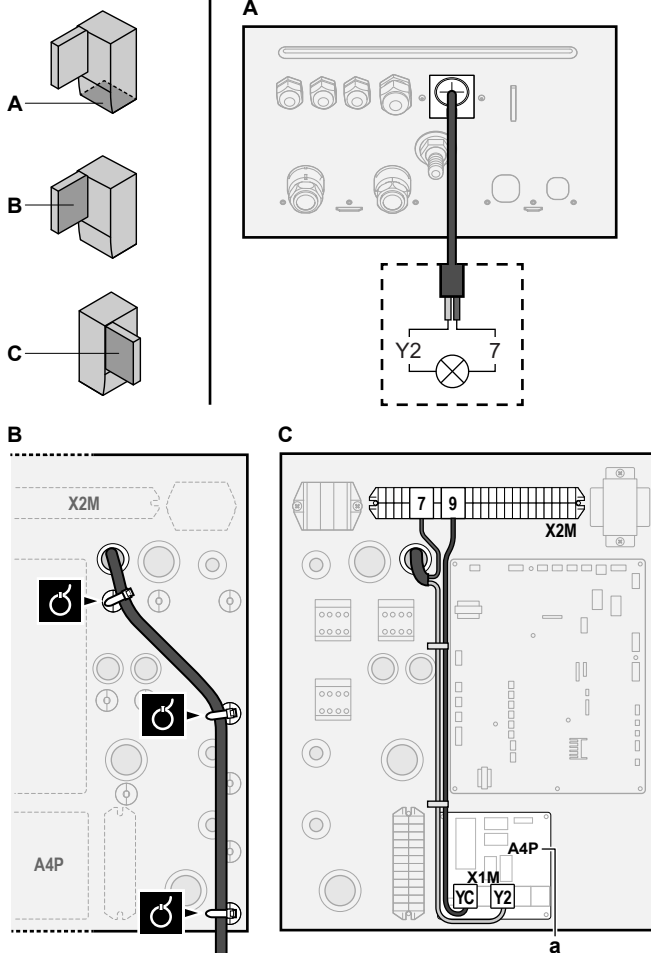
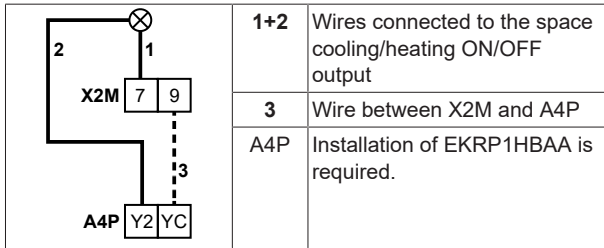

a Installation of EKR1HBAA is required.

- 3 Fix the cable with cable ties to the cable tie mountings.

6.3.8 To connect the changeover to external heat source

	Wires: 2×0.75 mm ²
	Maximum load: 0.3 A, 250 V AC
	Minimum load: 20 mA, 5 V DC
	[9.C] Bivalent

- 1 Open the following (see "4.2.1 To open the indoor unit" ▸ 6):

1	Front panel
2	Switch box cover
3	Switch box

- 2 Connect the changeover to external heat source cable to the appropriate terminals as shown in the illustration below.

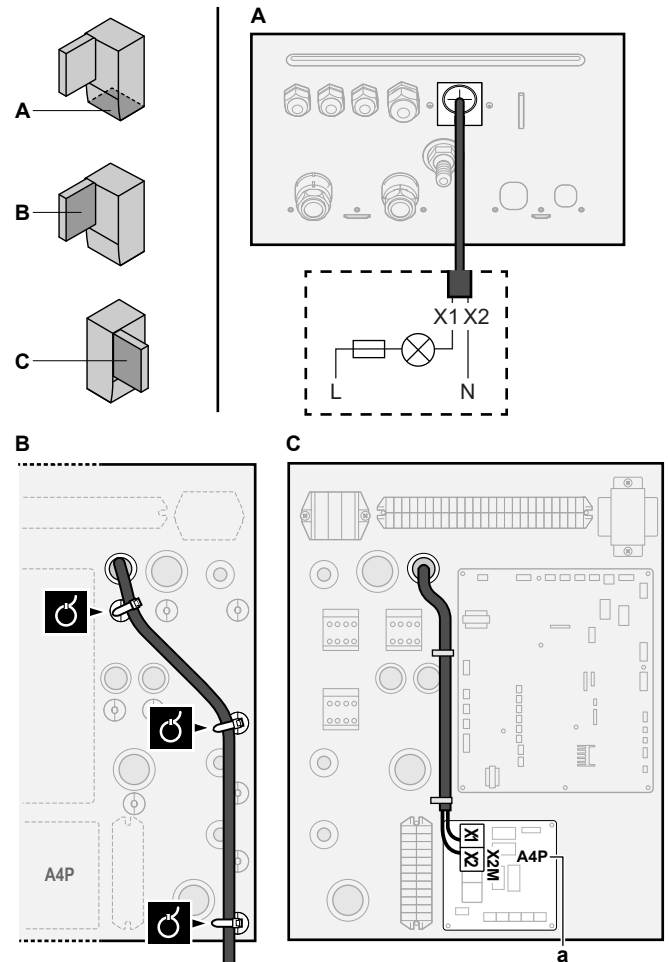

a Installation of EKR1HBAA is required.

- 3 Fix the cable with cable ties to the cable tie mountings.

6.3.9 To connect the power consumption digital inputs

	Wires: 2 (per input signal)×0.75 mm ²
	Power limitation digital inputs: 12 V DC / 12 mA detection (voltage supplied by PCB)
	[9.9] Power consumption control.

- 1 Open the following (see "4.2.1 To open the indoor unit" ▸ 6):

1	Front panel
2	Switch box cover
3	Switch box

- 2 Connect the power consumption digital inputs cable to the appropriate terminals as shown in the illustration below.

6 Electrical installation

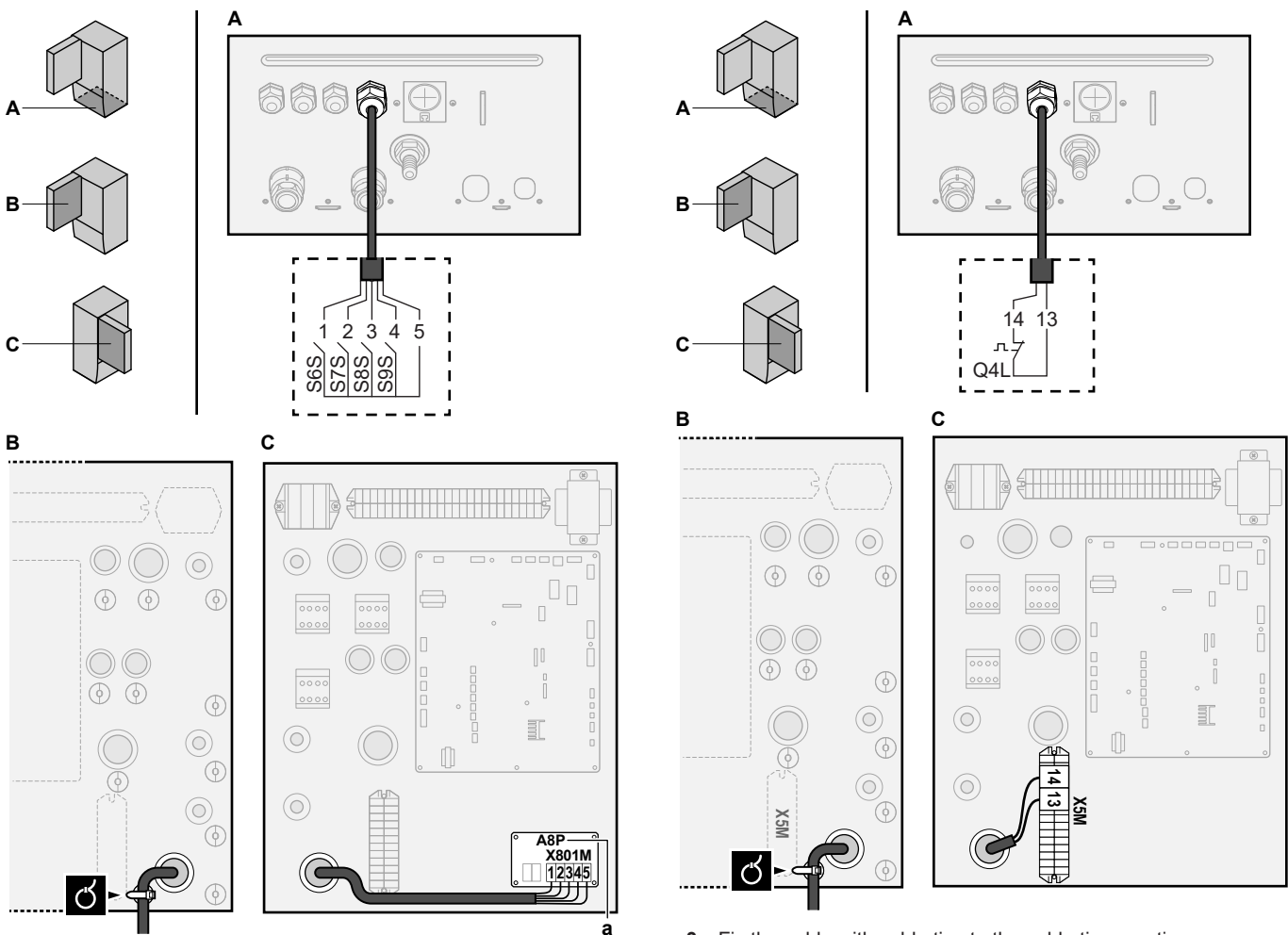

a Installation of EKRPAHTA is required.

3 Fix the cable with cable ties to the cable tie mountings.

6.3.10 To connect the safety thermostat (normally closed contact)

	Wires: 2×0.75 mm ² Maximum length: 50 m
	Safety thermostat contact: 16 V DC detection (voltage supplied by PCB). The voltage-free contact shall ensure the minimum applicable load of 15 V DC, 10 mA.
	—

1 Open the following (see "4.2.1 To open the indoor unit" [▶ 6]):

1	Front panel
2	Switch box cover
3	Switch box



2 Connect the safety thermostat (normally closed) cable to the appropriate terminals as shown in the illustration below.

Note: The jumper wire (factory-mounted) must be removed from the respective terminals.

3 Fix the cable with cable ties to the cable tie mountings.



NOTICE

Make sure to select and install the safety thermostat according to the applicable legislation.

In any case, to prevent unnecessary tripping of the safety thermostat, we recommend the following:

- The safety thermostat is automatically resettable.
- The safety thermostat has a maximum temperature variation rate of 2°C/min.
- There is a minimum distance of 2 m between the safety thermostat and the motorized 3-way valve delivered with the domestic hot water tank.



NOTICE

Error. If you remove the jumper (open circuit) but do NOT connect the safety thermostat, stop error 8H-03 will occur.



INFORMATION

The preferential kWh rate power supply contact is connected to the same terminals (X5M/9+10) as the safety thermostat. Thus, the system can have EITHER preferential kWh rate power supply OR a safety thermostat.

6.3.11 To connect a Smart Grid

This topic describes 2 possible ways to connect the indoor unit to a Smart Grid:

- In case of low voltage Smart Grid contacts
- In case of high voltage Smart Grid contacts. This requires the installation of the Smart Grid relay kit (EKRELSG).







The 2 incoming Smart Grid contacts can activate the following Smart Grid modes:

Smart Grid contact		Smart Grid operation mode
①	②	
0	0	Free running
0	1	Forced off
1	0	Recommended on
1	1	Forced on

The use of a Smart Grid pulse meter is not mandatory:

If Smart Grid pulse meter is...	Then [9.8.8] Limit setting kWh is...
Used ([9.A.2] Electricity meter 2 ≠ None)	Not applicable
Not used ([9.A.2] Electricity meter 2 = None)	Applicable

In case of low voltage Smart Grid contacts

	Wires (Smart Grid pulse meter): 0.5 mm ²
	Wires (low voltage Smart Grid contacts): 0.5 mm ²
	[9.8.4]=3 (Benefit kWh power supply = Smart grid)
	[9.8.5] Smart grid operation mode
	[9.8.6] Allow electrical heaters
	[9.8.7] Enable room buffering
	[9.8.8] Limit setting kW

The wiring of the Smart Grid in case of low voltage contacts is as follows:

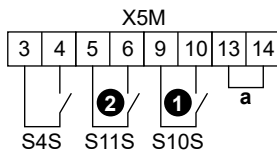

a Jumper (factory-mounted). If you also connect a safety thermostat (Q4L), replace the jumper with the safety thermostat wires.





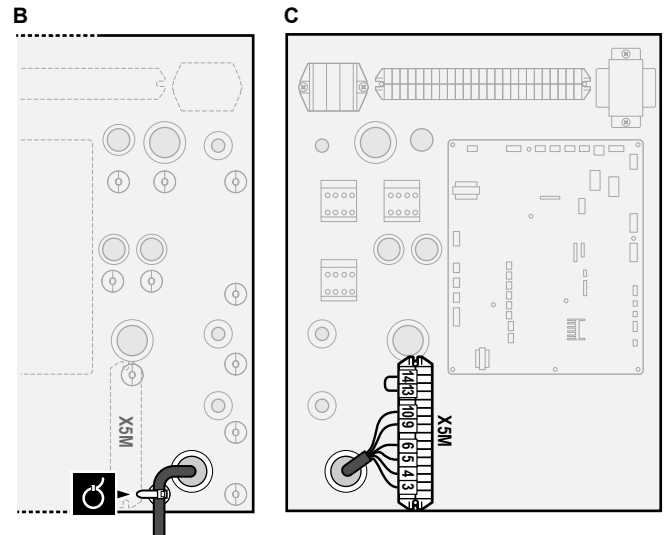
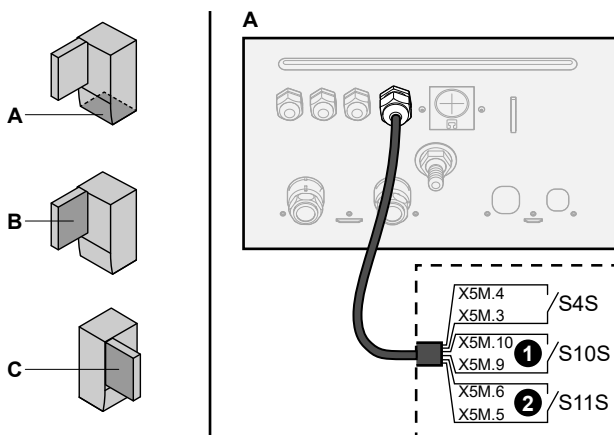

- S4S Smart Grid pulse meter
- ①/S10S Low voltage Smart Grid contact 1
- ②/S11S Low voltage Smart Grid contact 2

1 Connect the wiring as follows:



2 Fix the cables with cable ties to the cable tie mountings.

In case of high voltage Smart Grid contacts

	Wires (Smart Grid pulse meter): 0.5 mm ²
	Wires (high voltage Smart Grid contacts): 1 mm ²
	[9.8.4]=3 (Benefit kWh power supply = Smart grid)
	[9.8.5] Smart grid operation mode
	[9.8.6] Allow electrical heaters
	[9.8.7] Enable room buffering
	[9.8.8] Limit setting kW

The wiring of the Smart Grid in case of high voltage contacts is as follows:

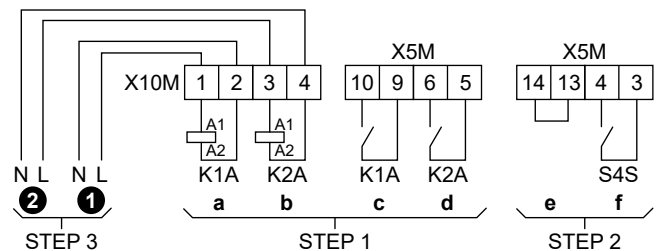

- STEP 1 Smart Grid relay kit installation
- STEP 2 Low voltage connections
- STEP 3 High voltage connections
- ① High voltage Smart Grid contact 1
- ② High voltage Smart Grid contact 2
- a, b Coil sides of relays
- c, d Contact sides of relays
- e Jumper (factory-mounted). If you also connect a safety thermostat (Q4L), replace the jumper with the safety thermostat wires.
- f Smart Grid pulse meter

1 Install the components of the Smart Grid relay kit as follows:

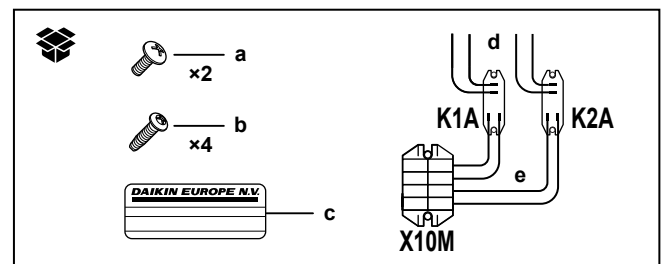

- K1A, K2A Relays
- X10M Terminal block
- a Screws for X10M
- b Screws for K1A and K2A
- c Sticker to put on the high voltage wires

6 Electrical installation

- d Wires between the relays and X5M (AWG22 ORG)
- e Wires between the relays and X10M (AWG18 RED)

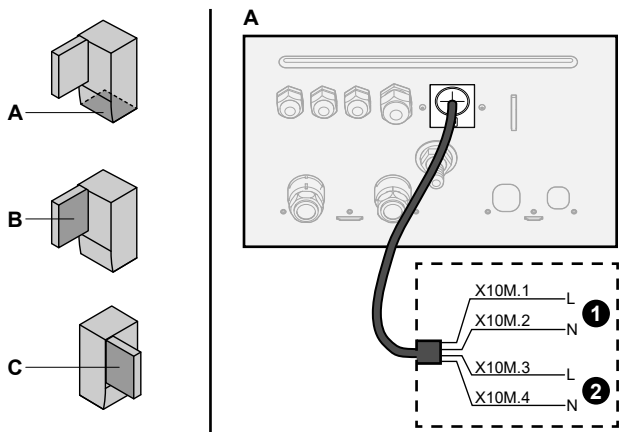
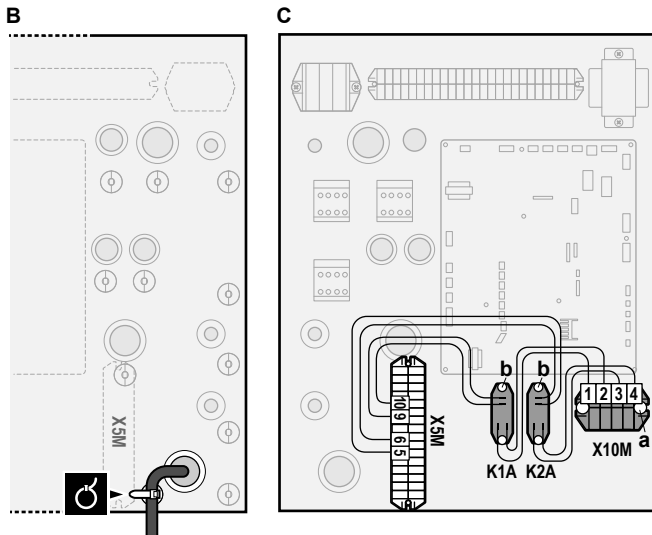

- ① High voltage Smart Grid contact 1
- ② High voltage Smart Grid contact 2

2 Connect the low voltage wiring as follows:

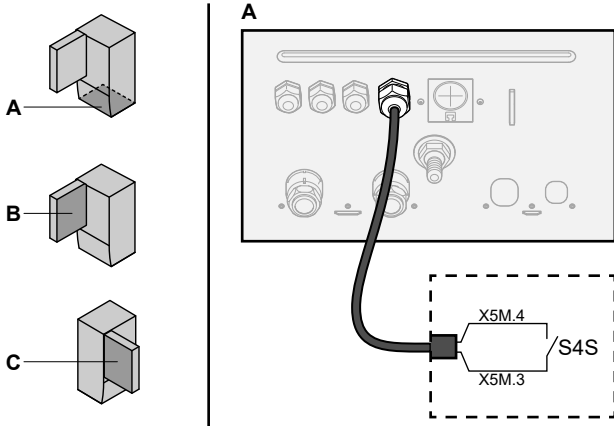

S4S Smart Grid pulse meter

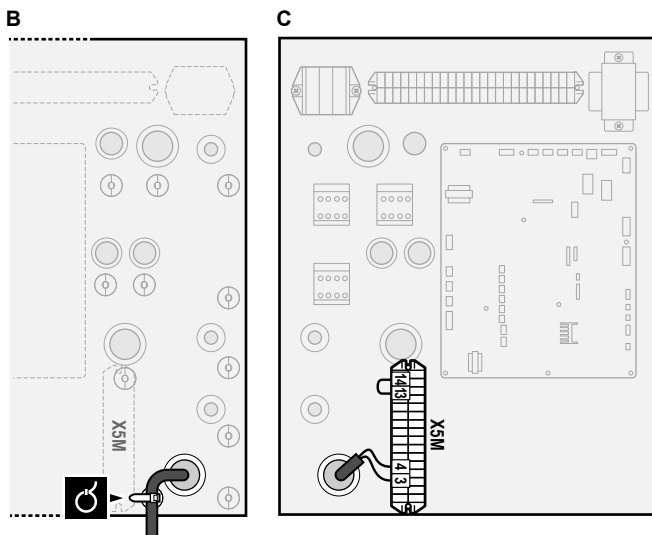

3 Connect the high voltage wiring as follows:

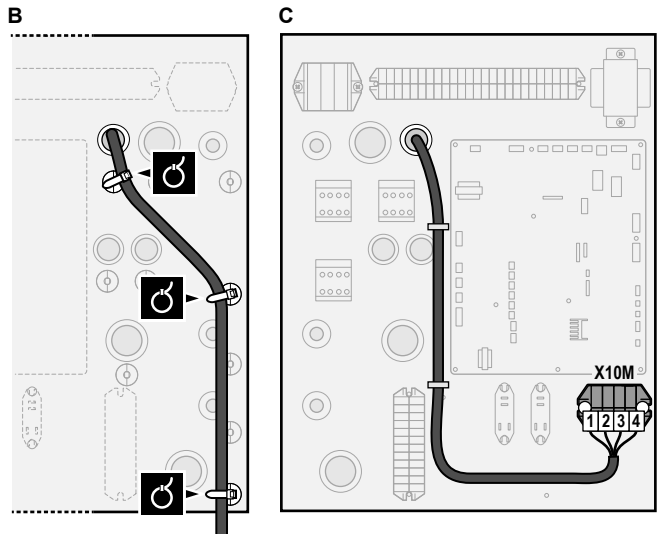

4 Fix the cables with cable ties to the cable tie mountings. If necessary, bundle excessive cable length with a cable tie.

6.3.12 To connect the WLAN cartridge (delivered as accessory)

[D] Wireless gateway

- 1 Insert the WLAN cartridge into the cartridge slot on the user interface of the indoor unit.

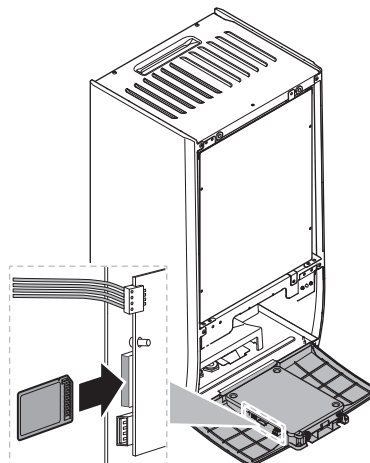

7 Configuration

i INFORMATION

Cooling is only applicable in case of:

- Reversible models
- Heating only models + conversion kit (EKHBCONV*)

7.1 Overview: Configuration

This chapter describes what you have to do and know to configure the system after it is installed.

! NOTICE

This chapter explains only the basic configuration. For more detailed explanation and background information, see the installer reference guide.

Why

If you do NOT configure the system correctly, it might NOT work as expected. The configuration influences the following:

- The calculations of the software
- What you can see on and do with the user interface

How

You can configure the system via the user interface.

- **First time – Configuration wizard.** When you turn ON the user interface for the first time (via the unit), the configuration wizard starts to help you configure the system.
- **Restart the configuration wizard.** If the system is already configured, you can restart the configuration wizard. To restart the configuration wizard, go to **Installer settings > Configuration wizard**. To access **Installer settings**, see ["7.1.1 To access the most used commands" \[p 21\]](#).
- **Afterwards.** If necessary, you can make changes to the configuration in the menu structure or the overview settings.

i INFORMATION

When the configuration wizard is finished, the user interface will show an overview screen and request to confirm. When confirmed, the system will restart and the home screen will be displayed.

Accessing settings – Legend for tables

You can access the installer settings using two different methods. However, NOT all settings are accessible via both methods. If so, the corresponding table columns in this chapter are set to N/A (not applicable).

Method	Column in tables
Accessing settings via the breadcrumb in the home menu screen or the menu structure . To enable breadcrumbs, press the ? button in the home screen.	# For example: [2.9]
Accessing settings via the code in the overview field settings .	Code For example: [C-07]





See also:

- ["To access the installer settings" \[p 21\]](#)
- ["7.5 Menu structure: Overview installer settings" \[p 30\]](#)

7.1.1 To access the most used commands

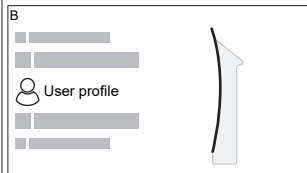
To change the user permission level

You can change the user permission level as follows:

1	Go to [B]: User profile.	
2	Enter the applicable pin code for the user permission level.	—
	▪ Browse through the list of digits and change the selected digit.	
	▪ Move the cursor from left to right.	
	▪ Confirm the pin code and proceed.	

Installer pin code

The Installer pin code is **5678**. Additional menu items and installer settings are now available.

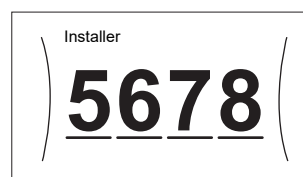

Advanced user pin code

The Advanced user pin code is **1234**. Additional menu items for the user are now visible.

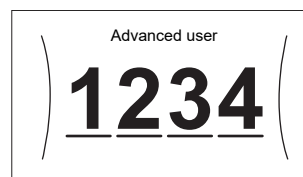

User pin code

The User pin code is **0000**.

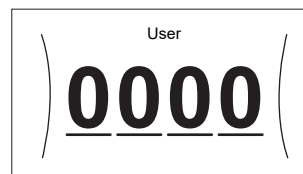

To access the installer settings

- 1 Set the user permission level to Installer.
- 2 Go to [9]: Installer settings.

To modify an overview setting

Example: Modify [1-01] from 15 to 20.

Most settings can be configured via the menu structure. If for any reason it is required to change a setting using the overview settings, then the overview settings can be accessed as follows:

1	Set the user permission level to Installer. See "To change the user permission level" [p 21] .	—
2	Go to [9.1]: Installer settings > Overview field settings.	

7 Configuration

3	Turn the left dial to select the first part of the setting and confirm by pressing the dial.	
4	Turn the left dial to select the second part of the setting	
5	Turn the right dial to modify the value from 15 to 20.	
6	Press the left dial to confirm the new setting.	
7	Press the center button to go back to the home screen.	

INFORMATION

When you change the overview settings and you go back to the home screen, the user interface will show a popup screen and request to restart the system.

When confirmed, the system will restart and recent changes will be applied.

7.2 Configuration wizard

After first power ON of the system, the user interface will guide you using the configuration wizard. This way you can set the most important initial settings. This way the unit will be able to run properly. Afterwards, more detailed settings can be done via the menu structure if required.

Protective functions

The unit is equipped with the following protective functions:

- Room antifrost [2-06]
- Water pipe freeze prevention [4-04]
- Tank disinfection [2-01]

The unit automatically runs the protective functions when necessary. During installation or service, this behaviour is undesired. Therefore, the protective functions can be disabled. For more information, see the Installer reference guide, chapter Configuration.

7.2.1 Configuration wizard: Language

#	Code	Description
[7.1]	N/A	Language

7.2.2 Configuration wizard: Time and date

#	Code	Description
[7.2]	N/A	Set the local time and date

INFORMATION

By default, daylight savings time is enabled and clock format is set to 24 hours. If you want to change these settings, you can do this in the menu structure (User settings > Time/date) once the unit is initialised.

7.2.3 Configuration wizard: System

Indoor unit type

The indoor unit type is displayed, but cannot be adjusted.

Backup heater type

The backup heater is adapted to be connected to most common European electricity grids. The type of backup heater can be viewed but not changed.

#	Code	Description
[9.3.1]	[E-03]	<ul style="list-style-type: none"> • 3: 6V • 4: 9W

Domestic hot water

The following setting determines if the system can prepare domestic hot water or not, and which tank is used. Set this setting according to the actual installation.

#	Code	Description
[9.2.1]	[E-05] ^(a)	• No DHW
	[E-06] ^(a)	• No tank installed.
	[E-07] ^(a)	<ul style="list-style-type: none"> • EKHWS/E, small volume • EKHWS/E, big volume • EKHWP/HYC • EKHWP/HYC • 3rd party, small coil • 3rd party, big coil

- ^(a) Use the menu structure instead of the overview settings. Menu structure setting [9.2.1] replaces the following 3 overview settings:
- [E-05]: Can the system prepare domestic hot water?
 - [E-06]: Is a domestic hot water tank installed in the system?
 - [E-07]: What kind of domestic hot water tank is installed?

In case of EKHWP, we recommend to use the following settings:

#	Code	Item	EKHWP
[9.2.1]	[E-07]	Tank type	5: EKHWP/HYC
N/A	[4-05]	Thermistor type	0: Automatic
[5.8]	[6-0E]	Maximum tank temperature	≤70°C

In case of EKHWS*D* / EKHWSU*D*, we recommend to use the following settings:

#	Code	Item	EKHWS*D* / EKHWSU*D*	
			150/180	200/250/300
[9.2.1]	[E-07]	Tank type	0: EKHWS/E, small volume	3: EKHWS/E, big volume

#	Code	Item	EKHWS*D* / EKHWSU*D*	
			150/180	200/250/300
N/A	[4-05]	Thermistor type	0: Automatic	1: Type 1
[5.8]	[6-0E]	Maximum tank temperature	≤60°C	≤75°C

In case of a third-party tank, we recommend to use the following settings:

#	Code	Item	Third-party tank	
			Coil≥1.05 m ²	Coil≥1.8 m ²
[9.2.1]	[E-07]	Tank type	7: 3rd party, small coil	8: 3rd party, big coil
N/A	[4-05]	Thermistor type	0: Automatic	1: Type 1
[5.8]	[6-0E]	Maximum tank temperature	≤60°C	≤75°C

Emergency

When the heat pump fails to operate, the backup heater and/or booster heater can serve as an emergency heater. It then takes over the heat load either automatically or by manual interaction.

- When Emergency is set to Automatic and a heat pump failure occurs, the backup heater automatically takes over the heat load, and the booster heater in the optional tank takes over the domestic hot water production.
- When Emergency is set to Manual and a heat pump failure occurs, the domestic hot water heating and space heating stops.

To manually recover it via the user interface, go to the Malfunctioning main menu screen and confirm whether the backup heater and/or booster heater can take over the heat load or not.

- Alternatively, when Emergency is set to:
 - auto SH reduced/DHW on, space heating is reduced but domestic hot water is still available.
 - auto SH reduced/DHW off, space heating is reduced and domestic hot water is NOT available.
 - auto SH normal/DHW off, space heating operates as normally but domestic hot water is NOT available.

Similarly as in Manual mode, the unit can take the full load with the backup heater and/or booster heater if the user activates this via the Malfunctioning main menu screen.

To keep energy consumption low, we recommend to set Emergency to auto SH reduced/DHW off if the house is unattended for longer periods.

#	Code	Description
[9.5.1]	[4-06]	<ul style="list-style-type: none"> 0: Manual 1: Automatic 2: auto SH reduced/DHW on 3: auto SH reduced/DHW off 4: auto SH normal/DHW off

i INFORMATION

The auto emergency setting can be set in the menu structure of the user interface only.

i INFORMATION

If a heat pump failure occurs and Emergency is set to Manual, the room frost protection function, the underfloor heating screed dryout function, and the water pipe antifreeze function will remain active even if the user does NOT confirm emergency operation.

Number of zones

The system can supply leaving water to up to 2 water temperature zones. During configuration, the number of water zones must be set.

i INFORMATION

Mixing station. If your system layout contains 2 LWT zones, you need to install a mixing station in front of the main LWT zone.

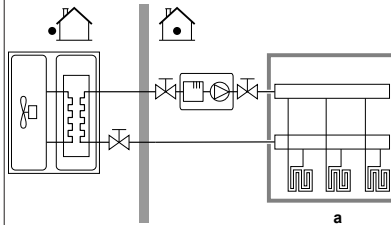
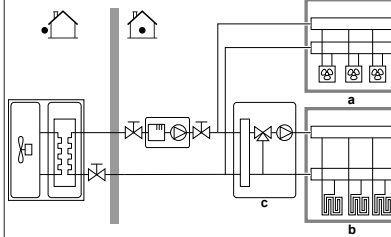
#	Code	Description
[4.4]	[7-02]	<ul style="list-style-type: none"> 0: Single zone <p>Only one leaving water temperature zone:</p>  <p>a Main LWT zone</p>
[4.4]	[7-02]	<ul style="list-style-type: none"> 1: Dual zone <p>Two leaving water temperature zones. The main leaving water temperature zone consists of the higher load heat emitters and a mixing station to achieve the desired leaving water temperature. In heating:</p>  <p>a Additional LWT zone: Highest temperature b Main LWT zone: Lowest temperature c Mixing station</p>

! NOTICE

NOT configuring the system in the following way can cause damage to the heat emitters. If there are 2 zones, it is important that in heating:

- the zone with the lowest water temperature is configured as the main zone, and
- the zone with the highest water temperature is configured as the additional zone.

! NOTICE

If there are 2 zones and the emitter types are wrongly configured, water of high temperature can be sent towards a low temperature emitter (underfloor heating). To avoid this:

- Install an aquastat/thermostatic valve to avoid too high temperatures towards a low temperature emitter.
- Make sure you set the emitter types for the main zone [2.7] and for the additional zone [3.7] correctly in accordance with the connected emitter.

7 Configuration



NOTICE

An overpressure bypass valve can be integrated in the system. Keep in mind that this valve might not be shown on the illustrations.

Glycol Filled system

This setting gives the installer the possibility to indicate whether the system is filled with glycol or water. This is important in case glycol is used to protect the water circuit against freezing. If NOT set correctly, the liquid in the piping can freeze.

#	Code	Description
N/A	[E-0D]	Glycol Filled system: Is the system filled with glycol? <ul style="list-style-type: none"> ▪ 0: No ▪ 1: Yes

Booster heater capacity

The capacity of the booster heater must be set for the energy metering and/or power consumption control feature to work properly. When measuring the resistance value of the booster heater, you can set the exact heater capacity and this will lead to more accurate energy data.

#	Code	Description
[9.4.1]	[6-02]	Booster heater capacity [kW]. Only applies to domestic hot water tank with an internal booster heater. The capacity of the booster heater at nominal voltage. Range: 0~10 kW

7.2.4 Configuration wizard: Backup heater

The backup heater is adapted to be connected to most common European electricity grids. If the backup heater is available, the voltage, configuration and capacity must be set on the user interface.

The capacities for the different steps of the backup heater must be set for the energy metering and/or power consumption control feature to work properly. When measuring the resistance value of each heater, you can set the exact heater capacity and this will lead to more accurate energy data.

Backup heater type

The backup heater is adapted to be connected to most common European electricity grids. The type of backup heater can be viewed but not changed.

#	Code	Description
[9.3.1]	[E-03]	<ul style="list-style-type: none"> ▪ 3: 6V ▪ 4: 9W

Voltage

- For a 6V model, this can be set to:
 - 230V, 1ph
 - 230V, 3ph
- For a 9W model, this is fixed to 400V, 3ph.

#	Code	Description
[9.3.2]	[5-0D]	<ul style="list-style-type: none"> ▪ 0: 230V, 1ph ▪ 1: 230V, 3ph ▪ 2: 400V, 3ph

Configuration

The backup heater can be configured in different ways. It can be chosen to have a 1-step only backup heater or a backup heater with 2 steps. If 2 steps, the capacity of the second step depends on this setting. It can also be chosen to have a higher capacity of the second step in emergency.

#	Code	Description
[9.3.3]	[4-0A]	<ul style="list-style-type: none"> ▪ 0: Relay 1 ▪ 1: Relay 1 / Relay 1+2 ▪ 2: Relay 1 / Relay 2 ▪ 3: Relay 1 / Relay 2 Emergency Relay 1+2



INFORMATION

Settings [9.3.3] and [9.3.5] are linked. Changing one setting influences the other. If you change one, check if the other is still as expected.



INFORMATION

During normal operation, the capacity of the second step of the backup heater at nominal voltage is equal to [6-03]+[6-04].



INFORMATION

If [4-0A]=3 and emergency mode is active, the power usage of the backup heater is maximal and equal to $2 \times [6-03] + [6-04]$.



INFORMATION

Only for systems with integrated domestic hot water tank: If the storage temperature setpoint is higher than 50°C, Daikin recommends NOT to disable the backup heater second step because it will have a big impact on the required time for the unit to heat up the domestic hot water tank.

Capacity step 1

#	Code	Description
[9.3.4]	[6-03]	<ul style="list-style-type: none"> ▪ The capacity of the first step of the backup heater at nominal voltage.

Additional capacity step 2

#	Code	Description
[9.3.5]	[6-04]	<ul style="list-style-type: none"> ▪ The capacity difference between the second and first step of the backup heater at nominal voltage. Nominal value depends on backup heater configuration.

7.2.5 Configuration wizard: Main zone

The most important settings for the main leaving water zone can be set here.

Emitter type

Heating up or cooling down the main zone can take longer. This depends on:

- The water volume of the system
- The heater emitter type of the main zone

The setting Emitter type can compensate for a slow or a quick heating/cooling system during the heat up/cool down cycle. In room thermostat control, Emitter type influences the maximum modulation of the desired leaving water temperature, and the possibility for usage of the automatic cooling/heating changeover based on the indoor ambient temperature.

It is important to set Emitter type correctly and in accordance with your system layout. The target delta T for the main zone depends on it.

#	Code	Description
[2.7]	[2-0C]	<ul style="list-style-type: none"> ▪ 0: Underfloor heating ▪ 1: Fancoil unit ▪ 2: Radiator

The setting of the emitter type has an influence on the space heating setpoint range and the target delta T in heating as follows:

Description	Space heating setpoint range	Target delta T in heating
0: Underfloor heating	Maximum 55°C	Variable
1: Fancoil unit	Maximum 55°C	Variable
2: Radiator	Maximum 65°C	Fixed 10°C



NOTICE

Average emitter temperature = Leaving water temperature – (Delta T)/2

This means that for a same leaving water temperature setpoint, the average emitter temperature of radiators is lower than that of underfloor heating because of a bigger delta T.

Example radiators: $40 - 10/2 = 35^\circ\text{C}$

Example underfloor heating: $40 - 5/2 = 37.5^\circ\text{C}$

To compensate, you can:

- Increase the weather-dependent curve desired temperatures [2.5].
- Enable leaving water temperature modulation and increase the maximum modulation [2.C].

Control

Define how the operation of the unit is controlled.

Control	In this control...
Leaving water	Unit operation is decided based on the leaving water temperature regardless the actual room temperature and/or heating or cooling demand of the room.
External room thermostat	Unit operation is decided by the external thermostat or equivalent (e.g. heat pump convector).
Room thermostat	Unit operation is decided based on the ambient temperature of the dedicated Human Comfort Interface (BRC1HHDA used as room thermostat).

#	Code	Description
[2.9]	[C-07]	<ul style="list-style-type: none"> ▪ 0: Leaving water ▪ 1: External room thermostat ▪ 2: Room thermostat

Setpoint mode

Define the setpoint mode:

- Fixed: the desired leaving water temperature does not depend on the outdoor ambient temperature.
- In WD heating, fixed cooling mode, the desired leaving water temperature:
 - depends on the outdoor ambient temperature for heating
 - does NOT depend on the outdoor ambient temperature for cooling

- In Weather dependent mode, the desired leaving water temperature depends on the outdoor ambient temperature.

#	Code	Description
[2.4]	N/A	Setpoint mode: <ul style="list-style-type: none"> ▪ Fixed ▪ WD heating, fixed cooling ▪ Weather dependent

When weather dependent operation is active, low outdoor temperatures will result in warmer water and vice versa. During weather dependent operation, the user can shift the water temperature up or down by a maximum of 10°C.

Schedule

Indicates if the desired leaving water temperature is according to a schedule. Influence of the LWT setpoint mode [2.4] is as follows:

- In Fixed LWT setpoint mode, the scheduled actions consist of desired leaving water temperatures, either preset or custom.
- In Weather dependent LWT setpoint mode, the scheduled actions consist of desired shift actions, either preset or custom.

#	Code	Description
[2.1]	N/A	<ul style="list-style-type: none"> ▪ 0: No ▪ 1: Yes

7.2.6 Configuration wizard: Additional zone

The most important settings for the additional leaving water zone can be set here.

Emitter type

For more info about this functionality, see ["7.2.5 Configuration wizard: Main zone"](#) [p 24].

#	Code	Description
[3.7]	[2-0D]	<ul style="list-style-type: none"> ▪ 0: Underfloor heating ▪ 1: Fancoil unit ▪ 2: Radiator

Control

The control type is displayed here, but cannot be adjusted. It is determined by the control type of the main zone. For more info about the functionality, see ["7.2.5 Configuration wizard: Main zone"](#) [p 24].

#	Code	Description
[3.9]	N/A	<ul style="list-style-type: none"> ▪ 0: Leaving water if the control type of the main zone is Leaving water. ▪ 1: External room thermostat if the control type of the main zone is External room thermostat or Room thermostat.

Setpoint mode

For more info about this functionality, see ["7.2.5 Configuration wizard: Main zone"](#) [p 24].

#	Code	Description
[3.4]	N/A	<ul style="list-style-type: none"> ▪ 0: Fixed ▪ 1: WD heating, fixed cooling ▪ 2: Weather dependent

If you choose WD heating, fixed cooling or Weather dependent, the next screen will be the detailed screen with weather-dependent curves. Also see ["7.3 Weather-dependent curve"](#) [p 26].

Schedule

Indicates if the desired leaving water temperature is according to a schedule. Also see ["7.2.5 Configuration wizard: Main zone"](#) [p 24].

7 Configuration

#	Code	Description
[3.1]	N/A	<ul style="list-style-type: none"> 0: No 1: Yes

7.2.7 Configuration wizard: Tank

This part only applies to systems with an optional domestic hot water tank installed.

Heat up mode

The domestic hot water can be prepared in 3 different ways. They differ from each other by the way the desired tank temperature is set and how the unit acts upon it.

#	Code	Description
[5.6]	[6-0D]	Heat up mode: <ul style="list-style-type: none"> 0: Reheat only: Only reheat operation is allowed. 1: Schedule + reheat: The domestic hot water tank is heated according to a schedule and between the scheduled heat up cycles, reheat operation is allowed. 2: Schedule only: The domestic hot water tank can ONLY be heated according to a schedule.

See the operation manual for more details.



INFORMATION

Risk of space heating capacity shortage for domestic hot water tank without internal booster heater: In case of frequent domestic hot water operation, frequent and long space heating/cooling interruption will happen when selecting the following:

Tank > Heat up mode > Reheat only.

Comfort setpoint

Only applicable when domestic hot water preparation is Schedule only or Schedule + reheat. When programming the schedule, you can make use of the comfort setpoint as a preset value. When you later want to change the storage setpoint, you only have to do it in one place.

The tank will heat up until the **storage comfort temperature** has been reached. It is the higher desired temperature when a storage comfort action is scheduled.

Additionally, a storage stop can be programmed. This feature puts a stop to tank heating even if the setpoint has NOT been reached. Only program a storage stop when tank heating is absolutely undesirable.

#	Code	Description
[5.2]	[6-0A]	Comfort setpoint: <ul style="list-style-type: none"> 30°C~[6-0E]°C

Eco setpoint

The **storage economic temperature** denotes the lower desired tank temperature. It is the desired temperature when a storage economic action is scheduled (preferably during day).

#	Code	Description
[5.3]	[6-0B]	Eco setpoint: <ul style="list-style-type: none"> 30°C~min(50,[6-0E])°C

Reheat setpoint

Desired reheat tank temperature, used:

- in Schedule + reheat mode, during reheat mode: the guaranteed minimum tank temperature is set by the Reheat setpoint minus the reheat hysteresis. If the tank temperature drops below this value, the tank is heated up.
- during storage comfort, to prioritize the domestic hot water preparation. When the tank temperature rises above this value, domestic hot water preparation and space heating/cooling are executed sequentially.

#	Code	Description
[5.4]	[6-0C]	Reheat setpoint: <ul style="list-style-type: none"> 30°C~min(50,[6-0E])°C

7.3 Weather-dependent curve

7.3.1 What is a weather-dependent curve?

Weather-dependent operation

The unit operates 'weather dependent' if the desired leaving water or tank temperature is determined automatically by the outdoor temperature. It therefore is connected to a temperature sensor on the North wall of the building. If the outdoor temperature drops or rises, the unit compensates instantly. Thus, the unit does not have to wait for feedback by the thermostat to increase or decrease the temperature of the leaving water or tank. Because it reacts more quickly, it prevents high rises and drops of the indoor temperature and water temperature at tap points.

Advantage

Weather-dependent operation reduces energy consumption.

Weather-dependent curve

To be able to compensate for differences in temperature, the unit relies on its weather-dependent curve. This curve defines how much the temperature of the tank or leaving water must be at different outdoor temperatures. Because the slope of the curve depends on local circumstances such as climate and the insulation of the house, the curve can be adjusted by an installer or user.

Types of weather-dependent curve

There are 2 types of weather-dependent curves:

- 2-points curve
- Slope-offset curve

Which type of curve you use to make adjustments, depends on your personal preference. See ["7.3.4 Using weather-dependent curves"](#) [p. 27].

Availability

The weather-dependent curve is available for:

- Main zone - Heating
- Main zone - Cooling
- Additional zone - Heating
- Additional zone - Cooling
- Tank (only available to installers)



INFORMATION

To operate weather dependent, correctly configure the setpoint of the main zone, additional zone or tank. See ["7.3.4 Using weather-dependent curves"](#) [p. 27].

7.3.2 2-points curve

Define the weather-dependent curve with these two setpoints:

- Setpoint (X1, Y2)
- Setpoint (X2, Y1)

Example

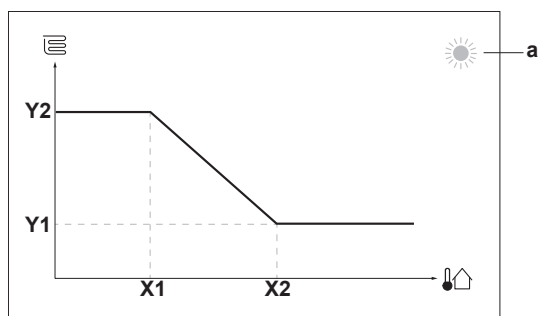

Item	Description
a	Selected weather dependent zone: <ul style="list-style-type: none"> ☀️: Main zone or additional zone heating ❄️: Main zone or additional zone cooling 🏠: Domestic hot water
X1, X2	Examples of outdoor ambient temperature
Y1, Y2	Examples of desired tank temperature or leaving water temperature. The icon corresponds to the heat emitter for that zone: <ul style="list-style-type: none"> 🏠: Underfloor heating 📄: Fan coil unit 🔱: Radiator 🏠: Domestic hot water tank

Possible actions on this screen	
⏪⦿⋯⦿	Go through the temperatures.
⦿⋯⦿⏩	Change the temperature.
⦿⋯⦿➡️	Go to the next temperature.
➡️⦿⋯⦿	Confirm changes and proceed.

7.3.3 Slope-offset curve

Slope and offset

Define the weather-dependent curve by its slope and offset:

- Change the **slope** to differently increase or decrease the temperature of the leaving water for different ambient temperatures. For example, if leaving water temperature is in general fine but at low ambient temperatures too cold, raise the slope so that leaving water temperature is heated increasingly more at decreasingly lower ambient temperatures.
- Change the **offset** to equally increase or decrease the temperature of the leaving water for different ambient temperatures. For example, if leaving water temperature is always a bit too cold at different ambient temperatures, shift the offset up to equally increase the leaving water temperature for all ambient temperatures.

Examples

Weather-dependent curve when slope is selected:

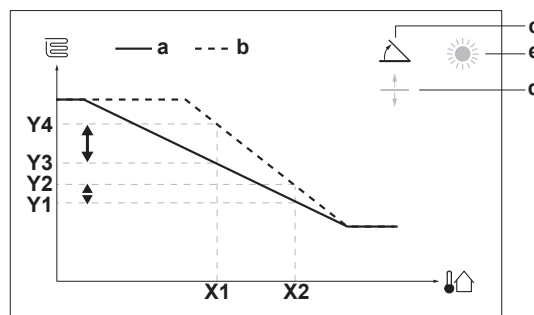

Weather-dependent curve when offset is selected:

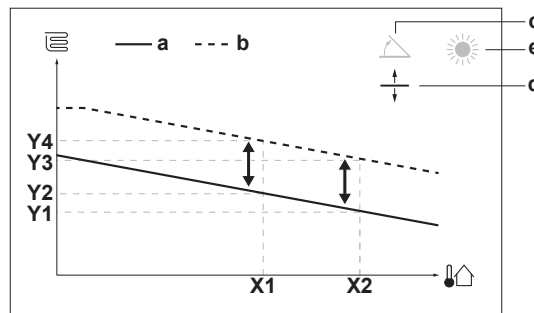

Item	Description
a	WD curve before changes.
b	WD curve after changes (as example): <ul style="list-style-type: none"> When slope is changed, the new preferred temperature at X1 is unequally higher than the preferred temperature at X2. When offset is changed, the new preferred temperature at X1 is equally higher as the preferred temperature at X2.
c	Slope
d	Offset
e	Selected weather dependent zone: <ul style="list-style-type: none"> ☀️: Main zone or additional zone heating ❄️: Main zone or additional zone cooling 🏠: Domestic hot water
X1, X2	Examples of outdoor ambient temperature
Y1, Y2, Y3, Y4	Examples of desired tank temperature or leaving water temperature. The icon corresponds to the heat emitter for that zone: <ul style="list-style-type: none"> 🏠: Underfloor heating 📄: Fan coil unit 🔱: Radiator 🏠: Domestic hot water tank

Possible actions on this screen	
⏪⦿⋯⦿	Select slope or offset.
⦿⋯⦿⏩	Increase or decrease the slope/offset.
⦿⋯⦿➡️	When slope is selected: set slope and go to offset. When offset is selected: set offset.
➡️⦿⋯⦿	Confirm changes and return to the submenu.

7.3.4 Using weather-dependent curves

Configure weather-dependent curves as following:

7 Configuration

To define the setpoint mode

To use the weather-dependent curve, you need to define the correct setpoint mode:

Go to setpoint mode ...	Set the setpoint mode to ...
Main zone – Heating	
[2.4] Main zone > Setpoint mode	WD heating, fixed cooling OR Weather dependent
Main zone – Cooling	
[2.4] Main zone > Setpoint mode	Weather dependent
Additional zone – Heating	
[3.4] Additional zone > Setpoint mode	WD heating, fixed cooling OR Weather dependent
Additional zone – Cooling	
[3.4] Additional zone > Setpoint mode	Weather dependent
Tank	
[5.B] Tank > Setpoint mode	Restriction: Only available to installers. Weather dependent

To change the type of weather-dependent curve

To change the type for all zones (main + additional) and for the tank, go to [2.E] Main zone > WD curve type.

Viewing which type is selected is also possible via:

- [3.C] Additional zone > WD curve type
- [5.E] Tank > WD curve type

Restriction: Only available to installers.

To change the weather-dependent curve

Zone	Go to ...
Main zone – Heating	[2.5] Main zone > Heating WD curve
Main zone – Cooling	[2.6] Main zone > Cooling WD curve
Additional zone – Heating	[3.5] Additional zone > Heating WD curve
Additional zone – Cooling	[3.6] Additional zone > Cooling WD curve
Tank	Restriction: Only available to installers. [5.C] Tank > WD curve



INFORMATION

Maximum and minimum setpoints

You cannot configure the curve with temperatures that are higher or lower than the set maximum and minimum setpoints for that zone or for the tank. When the maximum or minimum setpoint is reached, the curve flattens out.

To fine-tune the weather-dependent curve: slope-offset curve

The following table describes how to fine-tune the weather-dependent curve of a zone or tank:

You feel ...		Fine-tune with slope and offset:	
At regular outdoor temperatures ...	At cold outdoor temperatures ...	Slope	Offset
OK	Cold	↑	—
OK	Hot	↓	—
Cold	OK	↓	↑
Cold	Cold	—	↑

You feel ...		Fine-tune with slope and offset:	
At regular outdoor temperatures ...	At cold outdoor temperatures ...	Slope	Offset
Cold	Hot	↓	↑
Hot	OK	↑	↓
Hot	Cold	↑	↓
Hot	Hot	—	↓

To fine-tune the weather-dependent curve: 2-points curve

The following table describes how to fine-tune the weather-dependent curve of a zone or tank:

You feel ...		Fine-tune with setpoints:			
At regular outdoor temperatures ...	At cold outdoor temperatures ...	Y2 ^(a)	Y1 ^(a)	X1 ^(a)	X2 ^(a)
OK	Cold	↑	—	↑	—
OK	Hot	↓	—	↓	—
Cold	OK	—	↑	—	↑
Cold	Cold	↑	↑	↑	↑
Cold	Hot	↓	↑	↓	↑
Hot	OK	—	↓	—	↓
Hot	Cold	↑	↓	↑	↓
Hot	Hot	↓	↓	↓	↓

^(a) See "7.3.2 2-points curve" ▶ 26].

7.4 Settings menu

You can set additional settings using the main menu screen and its submenus. The most important settings are presented here.

7.4.1 Main zone

Thermostat type

Only applicable in external room thermostat control.



NOTICE

If an external room thermostat is used, the external room thermostat will control the room frost protection. However, the room frost protection is only possible if [C.2] Space heating/cooling=0n.

#	Code	Description
[2.A]	[C-05]	External room thermostat type for the main zone: <ul style="list-style-type: none"> • 1: 1 contact: The used external room thermostat can only send a thermo ON/OFF condition. There is no separation between heating or cooling demand. • 2: 2 contacts: The used external room thermostat can send a separate heating/cooling thermo ON/OFF condition.

7.4.2 Additional zone

Thermostat type

Only applicable in external room thermostat control. For more info about the functionality, see "7.4.1 Main zone" ▶ 28].

#	Code	Description
[3.A]	[C-06]	External room thermostat type for the additional zone: <ul style="list-style-type: none">▪ 1: 1 contact▪ 2: 2 contacts

7.4.3 Information

Dealer information

The installer can fill in his contact number here.

#	Code	Description
[8.3]	N/A	Number that users can call in case of problems.

7 Configuration

7.5 Menu structure: Overview installer settings

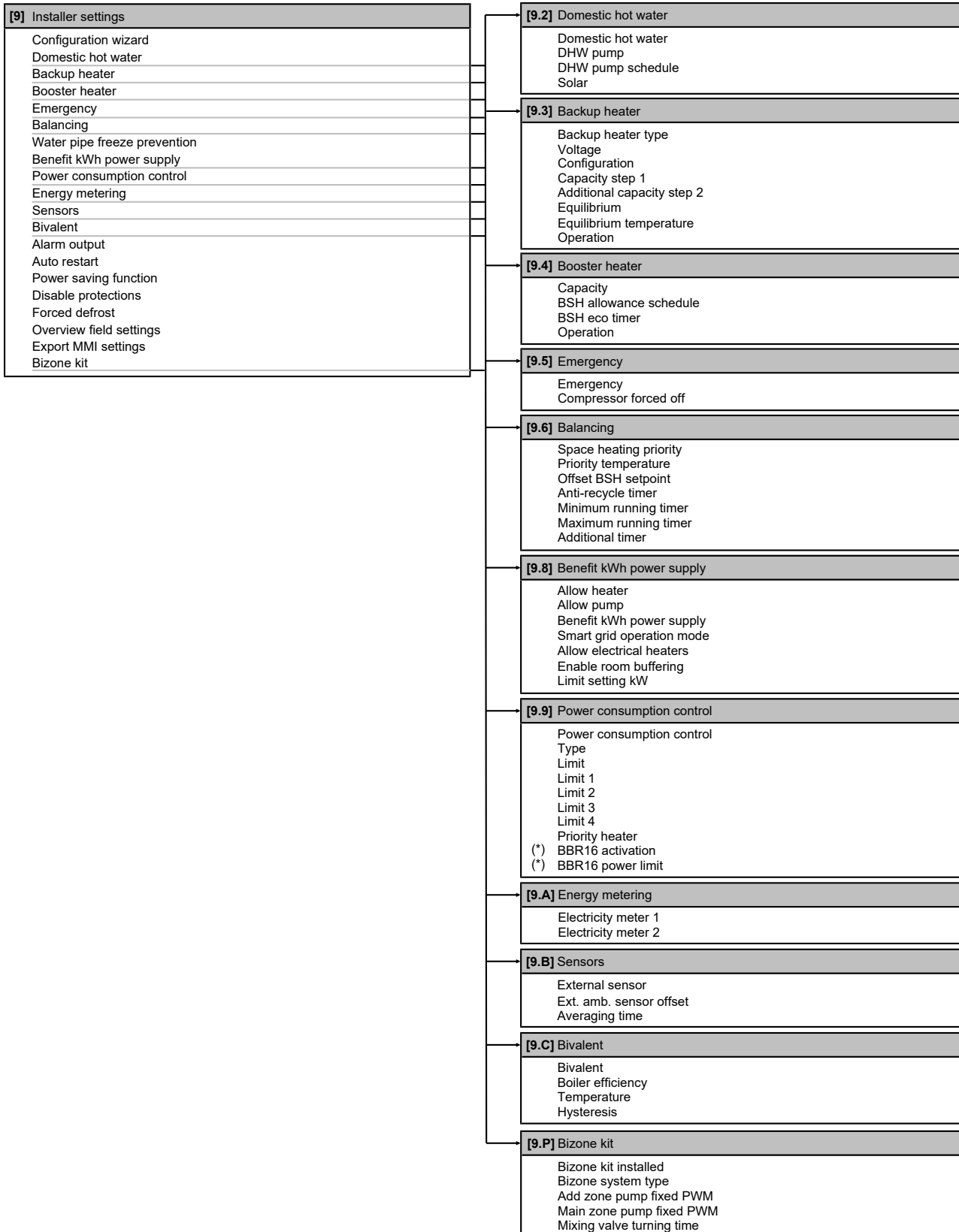

(* Only applicable in Swedish language.



INFORMATION

Solar kit settings are shown but are NOT applicable for this unit. Settings shall NOT be used or changed.



INFORMATION

Depending on the selected installer settings and unit type, settings will be visible/invisible.

8 Commissioning



NOTICE

General commissioning checklist. Next to the commissioning instructions in this chapter, a general commissioning checklist is also available on the Daikin Business Portal (authentication required).

The general commissioning checklist is complementary to the instructions in this chapter and can be used as a guideline and reporting template during the commissioning and hand-over to the user.



NOTICE

ALWAYS operate the unit with thermistors and/or pressure sensors/switches. If NOT, burning of the compressor might be the result.



NOTICE

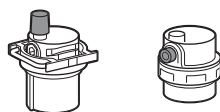

Make sure both air purge valves (one on the magnetic filter and one on the backup heater) are open.

All automatic air purge valves MUST remain open after commissioning.



INFORMATION

Protective functions – "Installer-on-site mode". The software is equipped with protective functions, such as room antifrost. The unit automatically runs these functions when necessary.

During installation or service this behaviour is undesired. Therefore, the protective functions can be disabled:

- **At first power-on:** The protective functions are disabled by default. After 12 hours they will be automatically enabled.
- **Afterwards:** An installer can manually disable the protective functions by setting [9.G]: Disable protections=Yes. After his work is done, he can enable the protective functions by setting [9.G]: Disable protections=No.

Also see "[Protective functions](#)" [▶ 22].

8.1 Checklist before commissioning

After the installation of the unit, first check the items listed below. Once all checks are fulfilled, the unit MUST be closed. Power-up the unit after it is closed.

<input type="checkbox"/>	You read the complete installation instructions, as described in the installer reference guide .
<input type="checkbox"/>	The indoor unit is properly mounted.
<input type="checkbox"/>	The outdoor unit is properly mounted.

<input type="checkbox"/>	The following field wiring has been carried out according to this document and the applicable legislation: <ul style="list-style-type: none"> ▪ Between the local supply panel and the outdoor unit ▪ Between indoor unit and outdoor unit ▪ Between the local supply panel and the indoor unit ▪ Between the indoor unit and the valves (if applicable) ▪ Between the indoor unit and the room thermostat (if applicable) ▪ Between the indoor unit and the domestic hot water tank (if applicable)
<input type="checkbox"/>	The system is properly earthed and the earth terminals are tightened.
<input type="checkbox"/>	The fuses or locally installed protection devices are installed according to this document, and have NOT been bypassed.
<input type="checkbox"/>	The power supply voltage matches the voltage on the identification label of the unit.
<input type="checkbox"/>	There are NO loose connections or damaged electrical components in the switch box.
<input type="checkbox"/>	There are NO damaged components or squeezed pipes on the inside of the indoor and outdoor units.
<input type="checkbox"/>	Backup heater circuit breaker F1B (field supply) is turned ON.
<input type="checkbox"/>	Only for tanks with built-in booster heater: Booster heater circuit breaker F2B (field supply) is turned ON.
<input type="checkbox"/>	The correct pipe size is installed and the pipes are properly insulated.
<input type="checkbox"/>	There is NO water leak inside the indoor unit.
<input type="checkbox"/>	The shut-off valves are properly installed and fully open.
<input type="checkbox"/>	The automatic air purge valves are open.
<input type="checkbox"/>	The pressure relief valve purges water when opened. Clean water MUST come out.
<input type="checkbox"/>	The minimum water volume is guaranteed in all conditions. See "To check the water volume and flow rate" in " 5.1 Preparing water piping " [▶ 7].
<input type="checkbox"/>	(if applicable) The domestic hot water tank is filled completely.

8.2 Checklist during commissioning

<input type="checkbox"/>	The minimum flow rate during backup heater/defrost operation is guaranteed in all conditions. See "To check the water volume and flow rate" in " 5.1 Preparing water piping " [▶ 7].
<input type="checkbox"/>	To perform an air purge .
<input type="checkbox"/>	To perform a test run .
<input type="checkbox"/>	To perform an actuator test run .
<input type="checkbox"/>	Underfloor screed dryout function The underfloor screed dryout function is started (if necessary).

8 Commissioning

8.2.1 To check the minimum flow rate

1	Check the hydraulic configuration to find out which space heating loops can be closed by mechanical, electronic, or other valves.	—
2	Close all space heating loops that can be closed.	—
3	Start the pump test run (see "8.2.4 To perform an actuator test run" ▶ 32).	—
4	Read out the flow rate ^(e) and modify the bypass valve setting to reach the minimum required flow rate + 2 l/min.	—

^(e) During pump test run, the unit can operate below the minimum required flow rate.

Minimum required flow rate	
20 l/min	

8.2.2 To perform an air purge

Conditions: Make sure all operation is disabled. Go to [C]: Operation and turn off Space heating/cooling and Tank operation.

1	Set the user permission level to Installer. See "To change the user permission level" ▶ 21.	—
2	Go to [A.3]: Commissioning > Air purge.	
3	Select OK to confirm. Result: The air purge starts. It stops automatically when air purge cycle is finished. To stop the air purge manually:	
1	Go to Stop air purge.	
2	Select OK to confirm.	

8.2.3 To perform an operation test run

Conditions: Make sure all operation is disabled. Go to [C]: Operation and turn off Space heating/cooling and Tank operation.

1	Set the user permission level to Installer. See "To change the user permission level" ▶ 21.	—
2	Go to [A.1]: Commissioning > Operation test run.	
3	Select a test from the list. Example: Heating.	
4	Select OK to confirm. Result: The test run starts. It stops automatically when ready (±30 min). To stop the test run manually:	
1	In the menu, go to Stop test run.	
2	Select OK to confirm.	

INFORMATION

If the outdoor temperature is outside the range of operation, the unit may NOT operate or may NOT deliver the required capacity.

To monitor leaving water and tank temperatures

During test run, the correct operation of the unit can be checked by monitoring its leaving water temperature (heating/cooling mode) and tank temperature (domestic hot water mode).

To monitor the temperatures:

1	In the menu, go to Sensors.	
2	Select the temperature information.	

8.2.4 To perform an actuator test run

Conditions: Make sure all operation is disabled. Go to [C]: Operation and turn off Space heating/cooling and Tank operation.

Purpose

Perform an actuator test run to confirm the operation of the different actuators. For example, when you select Pump, a test run of the pump will start.

1	Set the user permission level to Installer. See "To change the user permission level" ▶ 21.	—
2	Go to [A.2]: Commissioning > Actuator test run.	
3	Select a test from the list. Example: Pump.	
4	Select OK to confirm. Result: The actuator test run starts. It stops automatically when ready (±30 min). To stop the test run manually:	
1	In the menu, go to Stop test run.	
2	Select OK to confirm.	

Possible actuator test runs

- Booster heater test
- Backup heater 1 test
- Backup heater 2 test
- Pump test

INFORMATION

Make sure that all air is purged before executing the test run. Also avoid disturbances in the water circuit during the test run.

- Shut off valve test
- Diverter valve test (3-way valve for switching between space heating and tank heating)
- Bivalent signal test
- Alarm output test
- C/H signal test
- DHW pump test
- Bizone kit direct pump test (bizone kit EKMIKPOA or EKMIKPHA)
- Bizone kit mixed pump test (bizone kit EKMIKPOA or EKMIKPHA)
- Bizone kit mixing valve test (bizone kit EKMIKPOA or EKMIKPHA)

8.2.5 To perform an underfloor heating screed dryout

Conditions: Make sure all operation is disabled. Go to [C]: Operation and turn off Space heating/cooling and Tank operation.

1	Set the user permission level to Installer. See "To change the user permission level" ▶ 21.	—
2	Go to [A.4]: Commissioning > UFH screed dryout.	
3	Set a dryout program: go to Program and use the UFH screed dryout programming screen.	

4	Select OK to confirm. Result: The underfloor heating screed dryout starts. It stops automatically when done.	
	To stop the test run manually:	—
1	Go to Stop UFH screed dryout.	
2	Select OK to confirm.	

**NOTICE**

To perform an underfloor heating screed dryout, room frost protection needs to be disabled ([2-06]=0). By default, it is enabled ([2-06]=1). However, due to the "installer-on-site" mode (see "Commissioning"), room frost protection will be automatically disabled for 12 hours after the first power-on.

If the screed dryout still needs to be performed after the first 12 hours of power-on, manually disable room frost protection by setting [2-06] to "0", and KEEP it disabled until the screed dryout has finished. Ignoring this notice will result in cracking of the screed.

**NOTICE**

For the underfloor heating screed dryout to be able to start, make sure the following settings are met:

- [4-00]=1
- [C-02]=0
- [D-01]=0
- [4-08]=0
- [4-01]≠1

9 Hand-over to the user

Once the test run is finished and the unit operates properly, please make sure the following is clear for the user:

- Fill in the installer setting table (in the operation manual) with the actual settings.
- Make sure that the user has the printed documentation and ask him/her to keep it for future reference. Inform the user that he can find the complete documentation at the URL mentioned earlier in this manual.
- Explain the user how to properly operate the system and what to do in case of problems.
- Show the user what to do for the maintenance of the unit.
- Explain the user about energy saving tips as described in the operation manual.

10 Technical data



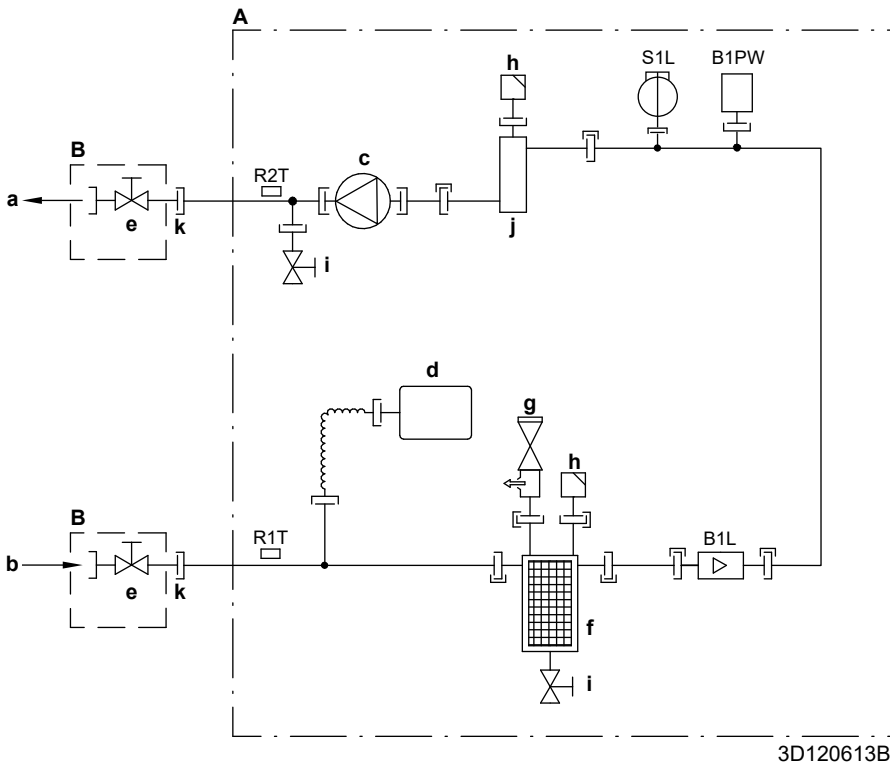

10 Technical data

A **subset** of the latest technical data is available on the regional Daikin website (publicly accessible). The **full set** of latest technical data is available on the Daikin Business Portal (authentication required).

10.1 Piping diagram: Indoor unit



3D120613B

- A** Indoor unit
- B** Field installed
- a** Space heating water OUT
- b** Water IN connection
- c** Pump
- d** Expansion vessel
- e** Shut-off valve, male-female 1"
- f** Magnetic filter/dirt separator
- g** Safety valve
- h** Air purge
- i** Drain valve
- j** Backup heater
- k** Loose nut 1"
- B1L** Flow sensor
- B1PW** Space heating water pressure sensor
- R1T** Thermistor (water IN)
- R2T** Thermistor (backup heater – water OUT)
- S1L** Flow switch
-  Screw connection
-  Flare connection
-  Quick coupling
-  Brazed connection

10.2 Wiring diagram: Indoor unit

See the internal wiring diagram supplied with the unit (on the inside of the indoor unit switch box cover). The abbreviations used are listed below.

Notes to go through before starting the unit

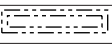
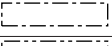
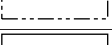
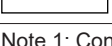
English	Translation
Notes to go through before starting the unit	Notes to go through before starting the unit
X1M	Main terminal
X2M	Field wiring terminal for AC
X5M	Field wiring terminal for DC
X6M	Backup heater power supply terminal
X7M, X8M	Booster heater power supply terminal
X10M	Smart grid terminal
-----	Earth wiring
-----	Field supply
①	Several wiring possibilities
	Option
	Not mounted in switch box
	Wiring depending on model
	PCB
Note 1: Connection point of the power supply for the BUH/BSH should be foreseen outside the unit.	Note 1: Connection point of the power supply for the backup heater/booster heater should be foreseen outside the unit.
Backup heater power supply	Backup heater power supply
<input type="checkbox"/> 6T1 (3~, 230 V, 6 kW)	<input type="checkbox"/> 6T1 (3~, 230 V, 6 kW)
<input type="checkbox"/> 6V3 (1N~, 230 V, 6 kW)	<input type="checkbox"/> 6V3 (1N~, 230 V, 6 kW)
<input type="checkbox"/> 6WN/9WN (3N~, 400 V, 6/9 kW)	<input type="checkbox"/> 6WN/9WN (3N~, 400 V, 6/9 kW)
User installed options	User installed options
<input type="checkbox"/> Remote user interface	<input type="checkbox"/> User interface used as room thermostat
<input type="checkbox"/> Ext. indoor thermistor	<input type="checkbox"/> External indoor thermistor
<input type="checkbox"/> Ext outdoor thermistor	<input type="checkbox"/> External outdoor thermistor
<input type="checkbox"/> Digital I/O PCB	<input type="checkbox"/> Digital I/O PCB
<input type="checkbox"/> Demand PCB	<input type="checkbox"/> Demand PCB
<input type="checkbox"/> Safety thermostat	Safety thermostat
<input type="checkbox"/> Smart Grid	Smart grid
<input type="checkbox"/> WLAN module	WLAN module
<input type="checkbox"/> WLAN cartridge	WLAN cartridge
<input type="checkbox"/> Bizone mixing kit	Bizone mixing kit
<input type="checkbox"/> Domestic hot water tank	<input type="checkbox"/> Domestic hot water tank
Main LWT	Main leaving water temperature
<input type="checkbox"/> On/OFF thermostat (wired)	<input type="checkbox"/> On/OFF thermostat (wired)
<input type="checkbox"/> On/OFF thermostat (wireless)	<input type="checkbox"/> On/OFF thermostat (wireless)
<input type="checkbox"/> Ext. thermistor	<input type="checkbox"/> External thermistor
<input type="checkbox"/> Heat pump convector	<input type="checkbox"/> Heat pump convector
Add LWT	Additional leaving water temperature
<input type="checkbox"/> On/OFF thermostat (wired)	<input type="checkbox"/> On/OFF thermostat (wired)
<input type="checkbox"/> On/OFF thermostat (wireless)	<input type="checkbox"/> On/OFF thermostat (wireless)
<input type="checkbox"/> Ext. thermistor	<input type="checkbox"/> External thermistor
<input type="checkbox"/> Heat pump convector	<input type="checkbox"/> Heat pump convector

Position in switch box

English	Translation
Position in switch box	Position in switch box

Legend

A1P	Main PCB
A2P	* On/OFF thermostat (PC=power circuit)
A3P	* Heat pump convector
A4P	* Digital I/O PCB
A8P	* Demand PCB
A11P	MMI (= user interface connected to the indoor unit) – Main PCB
A14P	* User interface PCB
A15P	* Receiver PCB (wireless On/OFF thermostat)
A20P	* WLAN module
A30P	* Bizone mixing kit PCB
BSK (A3P)	Solar pump station relay
CN* (A4P)	* Connector
DS1(A8P)	* DIP switch
F1B	# Overcurrent fuse backup heater
F2B	# Overcurrent fuse booster heater
F1T	Thermal fuse backup heater
F1U, F2U (A4P)	* Fuse 5 A 250 V for digital I/O PCB
K1A, K2A	* High voltage Smart grid relay
K1M, K2M	Contactorp backup heater
K3M	* Contactorp booster heater
K5M	Safety contactorp backup heater
K*R (A4P)	Relay on PCB
M2P	# Domestic hot water pump
M2S	# 2-way valve for cooling mode
M3S	* 3-way valve for space heating/domestic hot water
PC (A15P)	* Power circuit
PHC1 (A4P)	* Optocoupler input circuit
Q1L	Thermal protector backup heater
Q4L	# Safety thermostat
Q*DI	# Earth leakage circuit breaker
R1H (A2P)	* Humidity sensor
R1T (A2P)	* Ambient sensor On/OFF thermostat
R2T (A2P)	* External sensor (floor or ambient)
R5T	Domestic hot water thermistor
R6T	* External indoor or outdoor ambient thermistor
S1S	# Preferential kWh rate power supply contact
S2S	# Electrical meter pulse input 1
S3S	# Electrical meter pulse input 2
S4S	# Smart grid feed-in
S6S~S9S	* Digital power limitation inputs
S10S-S11S	# Low voltage Smart grid contact
SS1 (A4P)	* Selector switch
TR1	Power supply transformer
X6M	# Backup heater power supply terminal strip
X6M	* Booster heater power supply connector

10 Technical data

X7M, X8M		Booster heater power supply terminal strip
X10M	*	Smart grid power supply terminal strip
X*, X*A, X*Y*, Y*		Connector
X*M		Terminal strip

* Optional

Field supply

Translation of text on wiring diagram

English	Translation
(1) Main power connection	(1) Main power connection
For HP tariff	For heat pump tariff
Indoor unit supplied from outdoor	Indoor unit supplied from outdoor
Normal kWh rate power supply	Normal kWh rate power supply
Only for normal power supply (standard)	Only for normal power supply (standard)
Only for preferential kWh rate power supply (outdoor)	Only for preferential kWh rate power supply (outdoor)
Outdoor unit	Outdoor unit
Preferential kWh rate power supply contact: 16 V DC detection (voltage supplied by PCB)	Preferential kWh rate power supply contact: 16 V DC detection (voltage supplied by PCB)
SWB	Switch box
Use normal kWh rate power supply for indoor unit	Use normal kWh rate power supply for indoor unit
(2) Backup heater power supply	(2) Backup heater power supply
Only for ***	Only for ***
(3) User interface	(3) User interface
Only for remote user interface	Only for the user interface used as room thermostat
SD card	Card slot for WLAN cartridge
WLAN cartridge	WLAN cartridge
(4) Domestic hot water tank	(4) Domestic hot water tank
3 wire type SPST	3 wire type SPST
Booster heater power supply	Booster heater power supply
Only for ***	Only for ***
SWB	Switch box
(5) Ext. thermistor	(5) External thermistor
SWB	Switch box
(6) Field supplied options	(6) Field supplied options
12 V DC pulse detection (voltage supplied by PCB)	12 V DC pulse detection (voltage supplied by PCB)
230 V AC supplied by PCB	230 V AC supplied by PCB
Bizone mixing kit	Bizone mixing kit
Continuous	Continuous current
DHW pump output	Domestic hot water pump output
DHW pump	Domestic hot water pump
Electrical meters	Electrical meters
For HV smartgrid	For high voltage Smart Grid
For LV smartgrid	For low voltage Smart Grid
For safety thermostat	For safety thermostat
For smartgrid	For Smart Grid
Inrush	Inrush current
Max. load	Maximum load
Normally closed	Normally closed
Normally open	Normally open

English	Translation
Safety thermostat contact: 16 V DC detection (voltage supplied by PCB)	Safety thermostat contact: 16 V DC detection (voltage supplied by PCB)
Shut-off valve	Shut-off valve
Smartgrid contacts	Smart Grid contacts
Smartgrid PV power pulse meter	Smart Grid photovoltaic power pulse meter
SWB	Switch box
(7) Option PCBs	(7) Option PCBs
Alarm output	Alarm output
Changeover to ext. heat source	Changeover to external heat source
Max. load	Maximum load
Min. load	Minimum load
Only for demand PCB option	Only for demand PCB option
Only for digital I/O PCB option	Only for digital I/O PCB option
Options: external heat source output, solar pump connection, alarm output	Options: external heat source output, solar pump connection, alarm output
Options: On/OFF output	Options: On/OFF output
Power limitation digital inputs: 12 V DC / 12 mA detection (voltage supplied by PCB)	Power limitation digital inputs: 12 V DC / 12 mA detection (voltage supplied by PCB)
Refer to operation manual	Refer to the operation manual
Solar input	Solar input
Solar pump connection	Solar pump connection
Space C/H On/OFF output	Space cooling/heating On/OFF output
SWB	Switch box
(8) External On/OFF thermostats and heat pump convector	(8) External On/OFF thermostats and heat pump convector
Additional LWT zone	Additional leaving water temperature zone
Main LWT zone	Main leaving water temperature zone
Only for external sensor (floor/ambient)	Only for external sensor (floor or ambient)
Only for heat pump convector	Only for heat pump convector
Only for wired On/OFF thermostat	Only for wired On/OFF thermostat
Only for wireless On/OFF thermostat	Only for wireless On/OFF thermostat

Electrical connection diagram

For more details, please check the unit wiring.

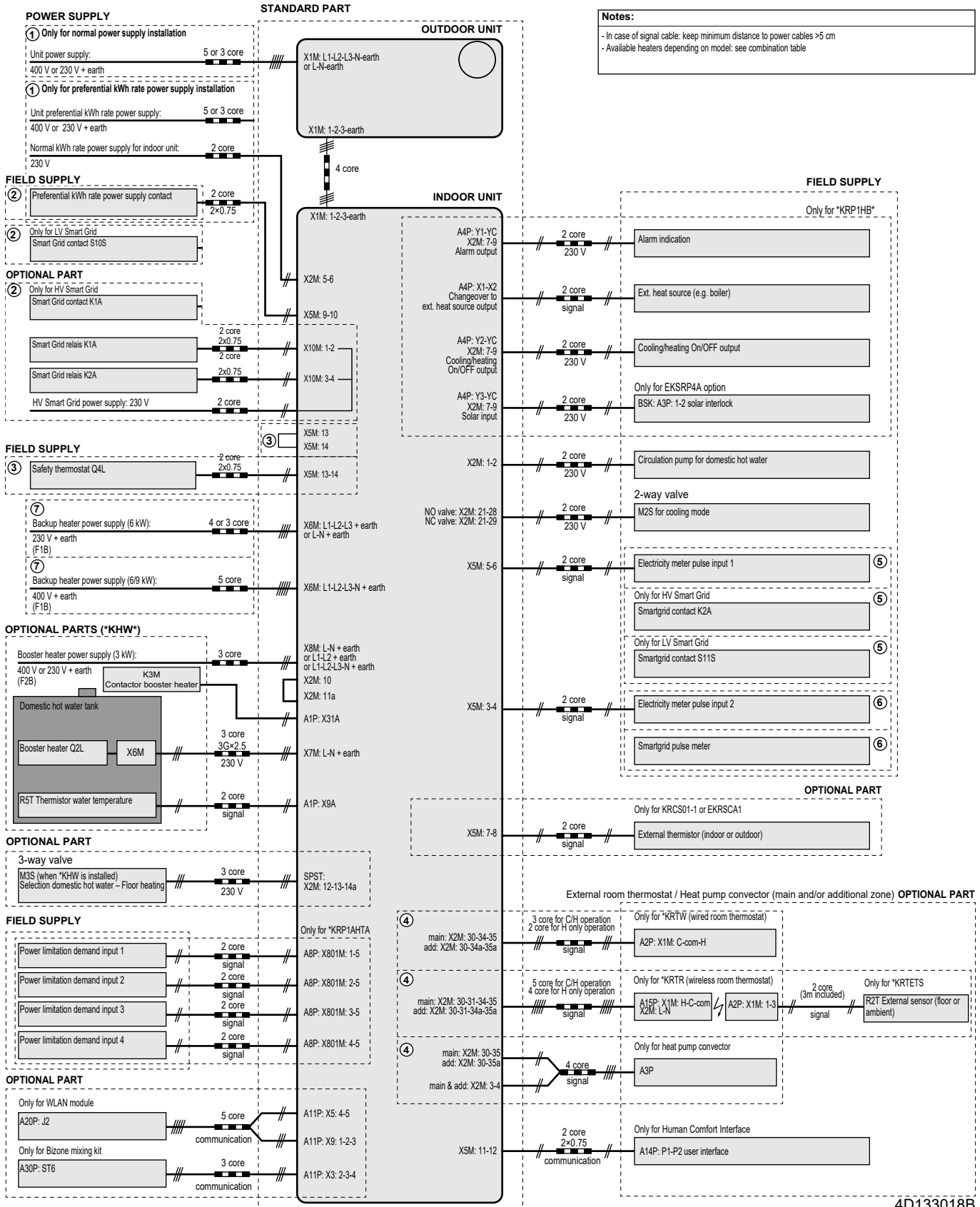

4D133018B

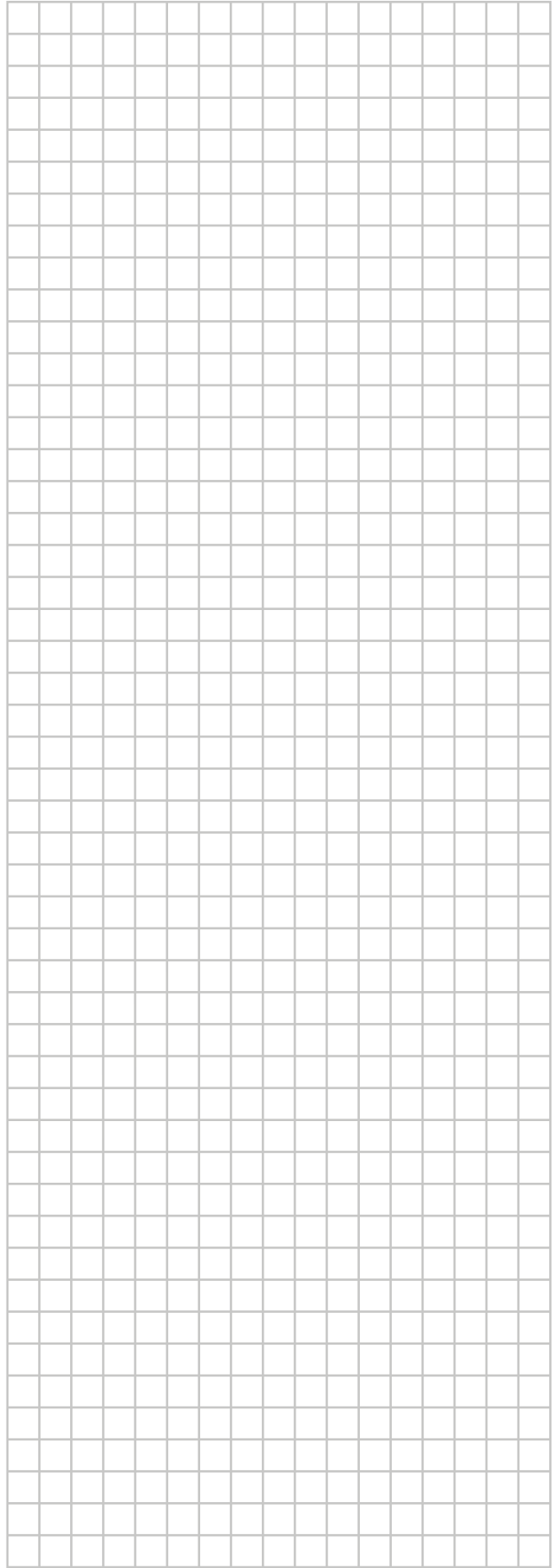



ERC



4P634879-1 000000Z

Copyright 2021 Daikin